

SONY®



Instruction manual

PSP-1001 K



UMD™
UNIVERSAL MEDIA DISC



MEMORY STICK PRO DUO
MEMORY STICK DUO



2-549-103-12(1) US

WARNINGS

To avoid electrical shock, do not open the cabinet. Refer servicing to qualified personnel only.

Use the supplied AC adaptor only. If you use other types, it may cause fire, electrical shocks or a malfunction.

For customers in the U.S.A. and Canada

Caution

The use of optical instruments with this product will increase eye hazard.



This appliance is classified as a CLASS 1 LASER product.

For customers in the U.S.A.

If you have questions about this product, call our technical support line at 1-800-345-7669, or write to:

Sony Computer Entertainment America
Consumer Services/Technical Support
PO Box 5888, San Mateo, CA 94402-0888 U.S.A.

Declaration of Conformity

Trade Name : SONY
Model No. : PSP-1001
Responsible Party : Sony Electronics Inc.
Address : 16450 W. Bernardo Dr. San Diego,
CA 92127 U.S.A.
Telephone No. : 858-942-2230

This device complies with Part 15 of the FCC Rules. Operation is subject to the following two conditions: (1) this device may not cause harmful interference, and (2) this device must accept any interference received, including interference that may cause undesired operation.

NOTE:

This equipment has been tested and found to comply with the limits for a Class B digital device, pursuant to Part 15 of the FCC rules. These limits are designed to provide reasonable protection against harmful interference in a residential installation. This equipment generates, uses, and can radiate radio frequency energy and, if not installed and used in accordance with the instructions, may cause harmful interference to radio communications. However, there is no guarantee that interference will not occur in a particular installation. If this equipment does cause harmful interference to radio or television reception, which can be determined by turning the equipment off and on, the user is encouraged to try to correct the interference by one or more of the following measures:

- Reorient or relocate the receiving antenna.
- Increase the separation between the equipment and receiver.
- Connect the equipment into an outlet on a circuit different from that to which the receiver is connected.
- Consult the dealer or an experienced radio/TV technician for help.

US

You are cautioned that any changes or modifications not expressly approved in this manual could void your authority to operate this equipment.

FCC Radiation Exposure Statement

This transmitter complies with FCC radiation exposure limit set forth for an uncontrolled environment. To comply with the FCC RF exposure compliance requirements, no change to the antenna or the device is permitted. Any changes to the antenna or the device could result in the device exceeding the RF exposure requirements and void user authorization to operate the equipment. In addition, this transmitter must not be co-located or operating in conjunction with any other antenna or transmitter.

Owner's Record

The model and serial numbers are located inside the battery compartment of the unit. Record the serial number in the space provided below. Refer to the number whenever you call for technical assistance at 1-800-345-7669.

Model No. PSP-1001

Serial No. _____

For customers in Canada

This Class B digital apparatus complies with Canadian ICES-003.

The term "IC" before the equipment certification number only signifies that the Industry Canada technical specifications were met.

Operation is subject to the following two conditions; (1) this device may not cause interference, and (2) this device must accept any interference, including interference that may cause undesired operation of the device.

IC Radiation Exposure Statement

This transmitter complies with IC radiation exposure limit set forth for an uncontrolled environment. To comply with the IC RF exposure compliance requirements, no change to the antenna or the device is permitted. Any changes to the antenna or the device could result in the device exceeding the RF exposure requirements and void user authorization to operate the equipment. In addition, this transmitter must not be co-located or operating in conjunction with any other antenna or transmitter.

Photosensitivity

A very small percentage of individuals may experience epileptic seizures when exposed to certain light patterns or flashing lights. Exposure to certain patterns or backgrounds on a television screen or while playing video games, including games played on the PSP™ system, may trigger an epileptic seizure in these individuals. Certain conditions may trigger previously undetected epileptic symptoms even in persons who have no history of prior seizures or epilepsy. If you, or anyone in your family, has an epileptic condition, consult your physician prior to playing. If you experience any of the following symptoms while playing a video game - dizziness, altered vision, eye or muscle twitches, loss of awareness, disorientation, any involuntary movement or convulsions - IMMEDIATELY discontinue use and consult your physician before resuming play.

Radio waves

Radio waves may affect electronic equipment or medical devices (for example, pacemakers), which may cause malfunctions and possible injuries.

- If you use a pacemaker or other medical device, consult your physician or the manufacturer of your medical device before using the wireless networking feature.
- Keep the PSP™ system at least 9 inches (23 cm) away from a pacemaker or other medical devices when using the wireless networking feature.
- Do not use the wireless networking feature in the following locations:
 - Areas where its use is prohibited, such as in airplanes or hospitals. Abide by medical institution regulations when using the PSP™ system on their premises. Additionally, you may be violating air safety regulations punishable by fines by using the wireless networking feature in an airplane or by using the PSP™ system during takeoff or landing.
 - Crowded areas.
 - Areas near fire alarms, automatic doors and other types of automated equipment.
- Use caution when using the wireless networking feature in a vehicle, as radio waves may affect electronic equipment in some vehicles.



GAME

→ page 41

- Playing games
- Managing saved data



VIDEO

→ page 45

- Playing UMD™ Video
- Playing videos (MPEG-4) saved on a Memory Stick Duo™



MUSIC

→ page 57

- Playing UMD™ Audio
- Playing music (ATRAC3plus™ or MP3) saved on a Memory Stick Duo™



PHOTO

→ page 70

- Displaying images (JPEG) saved on a Memory Stick Duo™
- Playing slideshows



SETTINGS

→ page 82

- Adjusting PSP™ system settings
- Creating video, photo or network settings
- Connecting to devices using the USB connector

Using the home menu

The basic operation of the PSP™ system starts from the home menu. Press the home button to display the home menu and use the directional buttons to navigate the horizontal and vertical icon bars.

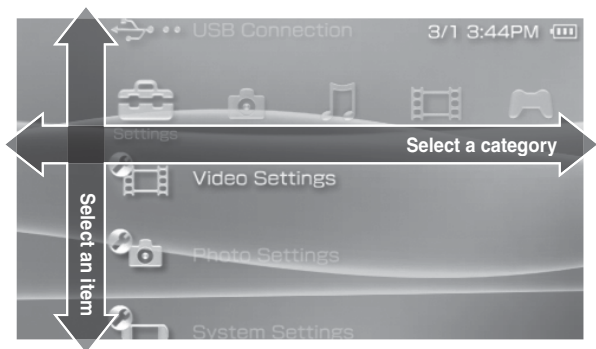

Basic button operations

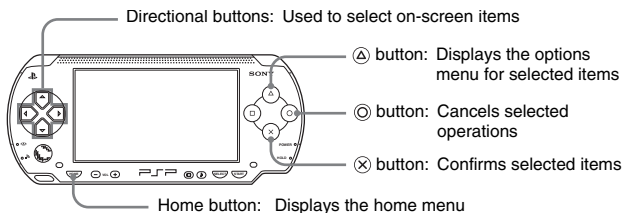

This manual includes instructions for the basic features of the PSP™ system. For additional information and answers to frequently asked questions about the PSP™ system, visit our Web site at <http://www.us.playstation.com/psp>
For more information on the use of Memory Stick Duo™ media, see <http://www.memorystick.com/psp>

Table of contents

WARNINGS	2
Precautions	11
Battery pack precautions	17

■ Preparation

Checking the package contents	19
Part names and functions	20
Preparing the PSP™ system for use	25
Connecting the headphones with remote control	28

■ Basic operations

Turning the PSP™ system on and off	29
Putting into sleep mode	31
Inserting a UMD™	32
Inserting a Memory Stick Duo™	33
Avoiding unintended operation of the PSP™ system	34
Using the sound button	35
Using the display button	37
Battery	38

■ Game

Playing a game	41
Game options menu	43
Copying and deleting saved data	44

■ Video

Watching a video	45
Using the control panel	47
Operating with PSP™ system buttons or the remote control	53
Video options menu	54
Saving videos on a Memory Stick Duo™	55

■ Music

Listening to music	57
Using the control panel	60
Operating with PSP™ system buttons or the remote control	64
Music options menu	65
Transferring and saving music on a Memory Stick Duo™	67

■ Photo

Viewing images	70
Using the control panel	71
Operating with PSP™ system buttons or the remote control	74
Photo options menu	75
Playing slideshows	76
Saving images on a Memory Stick Duo™	80

■ Settings

Settings for the PSP™ system	82
Video Settings	84
Photo Settings	85
System Settings	86
Date & Time Settings	89
Power Save Settings	90
Sound Settings	92
Security Settings	93
USB Connection	96
Network Settings	98
Network Update	104
How to use the keyboard	107

■ Additional information

Compatible media	110
Specifications	113
Troubleshooting	117
LIMITED WARRANTY	125

Precautions

Before using this product, carefully read this manual and retain it for future reference.

Safety

This product has been designed with the highest concern for safety. However, any electrical device, if used improperly, has the potential for causing fire, electrical shock or personal injury. To help ensure accident-free operation, follow these guidelines:

- Observe all warnings, precautions and instructions.
- Regularly inspect the AC adaptor and AC power cord for damage and for dust build-up around the power plug or electrical outlet.
- Stop use, unplug the AC power cord from the electrical outlet and disconnect any other cables immediately if the device functions in an abnormal manner, produces unusual sounds or smells or becomes too hot to touch.
- Call SCEA Consumer Services at 1-800-345-7669 if the device does not operate properly.

Use and handling

- Use in a well-lit area and keep the screen a safe distance from your face.
- Avoid prolonged use of the PSP™ system. To help prevent eyestrain, take a break of about 15 minutes during every hour of play.
- If you experience any of the following health problems, discontinue use of the system immediately. If symptoms persist, consult with your physician.
 - Dizziness, nausea, fatigue or symptoms similar to motion sickness
 - Discomfort or pain in a part of the body, such as eyes, ears, hands or arms
- Keep the system and accessories out of the reach of small children. Small children may swallow the Memory Stick Duo™ or wrap the cables around themselves, which may inflict injury or cause an accident or a malfunction.
- Do not use the system while driving or riding a bicycle. Looking at the screen or operating the system while driving an automobile or riding a bicycle may result in a traffic accident.
- Take extra care when using the system while walking.
- Be careful not to pinch your fingers when closing the disc cover.

- Do not use the system or accessories near water.
- Use only attachments/accessories specified by the manufacturer.
- Do not use the headphones if they cause discomfort to your skin.
If the supplied headphones cause discomfort to your skin, discontinue use immediately. If symptoms do not subside even after discontinuing use, seek medical attention.
- Do not expose the system or accessories to high temperatures, high humidity, or direct sunlight.
- Do not leave the system or accessories in a car with the windows closed (particularly in summer).
- Do not expose the system or accessories to dust, smoke or steam.
- Do not allow liquid or small particles to get into the system or accessories.
- Do not place the system or accessories on surfaces that are tilted, unstable or subject to vibration.
- Do not throw or drop the system or accessories, or subject the devices to strong physical shock. Handle the analog stick with care.
- Do not forcibly twist the PSP™ system or expose the system to strong physical shock during gameplay, as doing so can damage the system or cause the disc cover to open, ejecting the disc.
- Do not put heavy objects on the system or accessories.
- Do not touch or insert foreign objects into the connectors of the system or accessories.
- Do not place the system close to items with a magnetic strip, such as credit cards.
- Do not touch the system or AC adaptor for an extended period of time while in use. Depending on the conditions of use, the system or AC adaptor may reach temperatures of 40° C/104° F or more. Extended contact under these conditions may cause low-temperature burns*.

* Low-temperature burns are burns that occur when the skin is in contact with objects of relatively low temperatures (40°C or more/104°F or more) for an extended period of time.

AC adaptor and AC power cord use

- Do not touch the plug of the AC power cord with wet hands.
- Do not touch the AC power cord, AC adaptor or the system, if connected to an electrical outlet, during an electrical storm.
- Do not use a power source other than the supplied battery pack, AC adaptor and AC power cord.

- Do not allow dust or foreign matter to build up around the system or accessory connectors. If there is dust or foreign matter on the system's connectors or the AC power cord, wipe it off with a dry cloth before connecting. Dust or other matter on the connectors can result in fire or electrical shock.
- Unplug the AC power cord from the electrical outlet and remove the battery pack from the system before cleaning or when you do not intend to use the system for an extended period of time.
- Protect the AC power cord from being walked on or pinched particularly at plugs, convenience receptacles and the point where they exit from the system.
- When disconnecting the AC power cord, hold it by the plug and pull straight out from the electrical socket. Never pull by the cord and do not pull at an angle.
- Do not use the system to play games or video when the system is covered with any type of fabric. If you want to pause or temporarily store the system while playing games or video, put the system in sleep mode before placing it in the pouch. Also do not use the AC adaptor when covered with fabric. This may help to avoid overheating.
- Do not connect the AC power cord to a voltage transformer or inverter. Connecting the AC power cord to a voltage transformer for overseas travel or an inverter for use in an automobile may cause heat to build up in the AC adaptor and may cause burns or a malfunction.

LCD screen

- Red, blue or green spots (bright spots) or black spots (dark spots) may appear in certain locations on the LCD screen. The appearance of such spots is a normal occurrence associated with LCD screens and is not a sign of a malfunction. LCD screens are made using highly precise technology. However, a very small number of dark pixels or continuously lit pixels exist on each screen. Also, a distorted image may remain on the screen for several seconds after the system has been turned off.
- Direct exposure to sunlight may damage the system's LCD screen. Be careful when using the system outdoors or near a window.
- When using the system in a cold environment, you may notice shadows on the graphics or the screen may appear darker than usual. This is not a malfunction, and the screen will return to normal when the temperature goes up.
- Do not leave still images displayed on the screen for an extended period of time. This may cause a faint image to be left permanently on the screen.

Memory Stick Duo™

For best results, follow these guidelines:

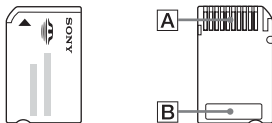

- Do not touch the connector area (A) with your hands or with metal objects.
- Do not press hard when writing on the memo area (B).
- Do not insert a Memory Stick Duo™ into a device designed to accept only standard-size Memory Stick™ media.
- Do not use or store a Memory Stick Duo™ in the following:
 - Places subject to high temperatures, such as in a hot vehicle
 - Locations exposed to direct sunlight
 - Locations that are very humid or conducive to corrosion
- Use the supplied case to carry or store the Memory Stick Duo™.

■ Recorded data

Do not use the Memory Stick Duo™ in the following ways, as doing so may result in data loss or corruption:

- Removing the Memory Stick Duo™ or turning off the system while it is loading or saving data or being formatted.
- Using it in a location that is exposed to static electricity or electrical interference.

If, for any reason, software or data loss or corruption occurs, it is usually not possible to recover the software or data. It is recommended that you regularly back up software and data. Sony Computer Entertainment Inc. and its subsidiaries and affiliates will not be held liable for any damages or injury in the case of software or data loss or corruption.

In accordance with copyright law, no recorded data may be used for purposes other than personal enjoyment without permission from the copyright holder.

Pouch and wrist strap

- If you want to pause or temporarily store the system while playing games or video, put the system in sleep mode before placing it in the pouch. This may help to avoid overheating.
- Put both the PSP™ system and the remote control in hold mode to help prevent unintended operation.
- Keep the pouch and wrist strap out of the reach of small children.

Never disassemble the system or supplied accessories

Use the PSP™ system and accessories according to the instructions in this manual. No authorization for the analysis or modification of the system, or the analysis and use of its circuit configurations, is provided. Disassembling will void the system warranty. Additionally, there is a risk of fire, electrical shock or malfunction. The LCD screen, in particular, contains dangerous, high-voltage parts, and the laser beam for reading UMD™ may cause visual impairment if exposed directly to the eyes.

Overseas use

Depending on the country, there are limitations on the use of certain types of radio waves. In some cases, use of the system may lead to a fine or other penalty.

Moisture condensation

If the PSP™ system or UMD™ is brought directly from a cold location to a warm one, moisture may condense on the lens inside the system or on the UMD™. Should this occur, the system may not operate properly. In this case, remove the UMD™ and turn off and unplug the system. Do not put the UMD™ back in until the moisture evaporates (this may take several hours). If the system still does not operate properly, contact our technical support line at 1-800-345-7669 for assistance.

UMD™ handling

- Do not touch the opening on the rear of the disc (recorded surface of the disc) with your fingers.
- Do not allow dust, sand, foreign objects or other types of dirt to get on the disc.

- If the UMD™ becomes dirty, gently wipe the exterior and recorded surfaces of the UMD™ using a soft cloth. Do not use solvents or other chemicals.

Cleaning

For safety reasons, unplug the AC power cord from the electrical outlet and remove the battery pack from the system before cleaning.

■ Cleaning the exterior surface

Wipe gently with a damp cloth, and then dry the surface. Do not use solvents or other chemicals to clean the exterior of the PSP™ system.

■ Cleaning the LCD screen

Wipe gently with a soft cloth.

■ Cleaning the connectors

- Do not use when the connectors of the system, AC adaptor or the AC power cord are not clean. Remove the dirt with a dry cloth or cotton swab. If used when dirty, the flow of electrical current may be obstructed.
- If the headphones or remote control connectors become dirty, this could cause noise or interruptions in sound. Wipe the connectors with a dry, soft cloth to keep in clean condition.

Battery pack precautions



Warnings

Do not handle a damaged or leaking battery pack.

Contact with the material can result in injury or burns to the eyes or skin. Even if foreign substances are not immediately visible, chemical changes in the material can result in injuries occurring at a later time.

If you come into contact with material from a leaking battery pack, take the following actions:

- If the material gets into the eyes, do not rub. Immediately flush the eyes with clean water and seek medical attention.
- If the material comes into contact with the skin or clothes, immediately rinse the affected area with clean water. Consult your physician if inflammation or soreness develops.

Handle the battery pack with care.

The battery pack may explode or present a fire or chemical burn hazard if it is not handled carefully.

- Do not allow the battery pack to come into contact with fire or subject it to extreme temperatures such as in direct sunlight, in a vehicle exposed to the sun or near a heat source.
- Do not cause the battery pack to short-circuit.
- Do not disassemble or tamper with the battery pack.
- Prevent damage to the battery pack. Do not carry or store the battery pack with metal items such as coins or keys. If damaged, discontinue use.
- Do not throw or drop the battery pack or subject it to strong physical shock.
- Do not put heavy objects on or apply pressure to the battery pack.
- Do not allow the battery pack to come into contact with liquids. If it becomes wet, discontinue use until it is completely dry.
- Keep the battery pack out of the reach of small children.
- If the PSP™ system will not be used for an extended period of time, remove the battery pack and store it in a cool, dry place out of the reach of children.
- Use only the supplied battery pack or a replacement marked for use with the PSP™ system.
- Use only the designated AC adaptor to charge the battery pack.

Recycling Lithium-Ion Batteries

Lithium-Ion batteries are recyclable.

You can help preserve our environment by returning your used rechargeable batteries to the collection and recycling location nearest you.



For more information regarding recycling of rechargeable batteries, call toll free 1-800-822-8837, or visit <http://www.rbrrc.org/>



Caution

Do not handle damaged or leaking Lithium-Ion batteries.

Checking the package contents

Check that you have all of the following items. If any items are missing, contact our technical support line at 1-800-345-7669 for assistance.

- PSP™ system

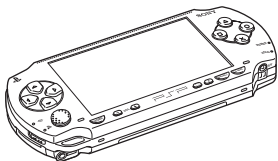

- Battery pack



- Headphones with remote control

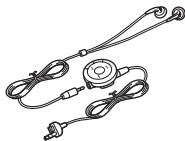

- AC adaptor



- AC power cord



- Memory Stick Duo™ (32 MB)

- Wrist strap

- Pouch

- Cloth

- UMD™ software

- Printed materials

Part names and functions

System front

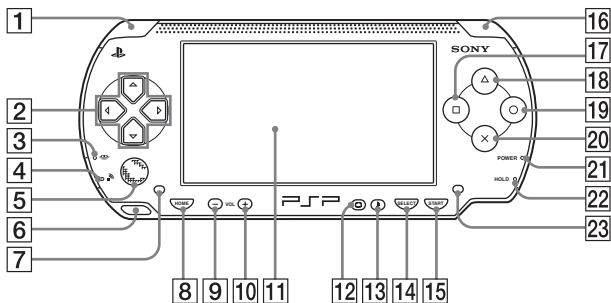

1 L button

2 Directional buttons

3 Memory Stick Duo™ access indicator

Lights up when saving and loading data

4 WLAN access indicator

Lights up when using the wireless networking feature

5 Analog stick

Can be used with games that support analog operation

6 Strap holder

Attach as shown in the diagram.

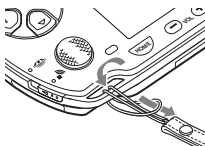

7 Left speaker

8 Home button

Displays the home menu

9 Volume - button

Turns the volume down

10 Volume + button

Turns the volume up

- 11 **LCD screen**
- 12 **Display button**
Adjusts screen brightness
(☛ page 37)
- 13 **Sound button**
Adjusts the tone (☛ page 35)
- 14 **Select button**
- 15 **Start button**
- 16 **R button**
- 17 **□ button**
- 18 **△ button**
- 19 **○ button**
- 20 **× button**
- 21 **Power indicator**
Lights up, flashes or changes color to indicate system status
(☛ page 29)
- 22 **Hold indicator**
Turns yellow when in hold mode
(☛ page 34)
- 23 **Right speaker**

System rear

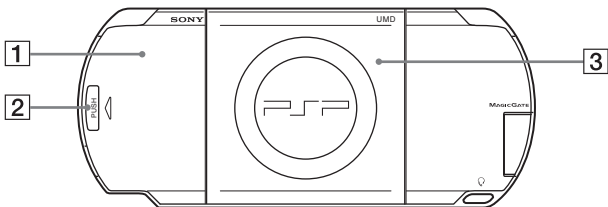

- 1 **Battery cover**
- 2 **Push button**
- 3 **Disc cover**

System top

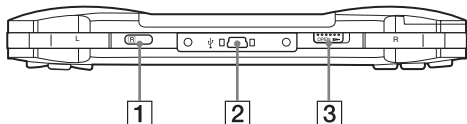

1 IR port

3 Open latch

2 USB connector

System bottom



1 Headset connector

3 DC IN 5V connector

2 Charging terminals

System left side

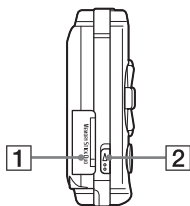

1 Memory Stick Duo™ slot*

2 WLAN switch

Turns on the wireless networking feature

System right side

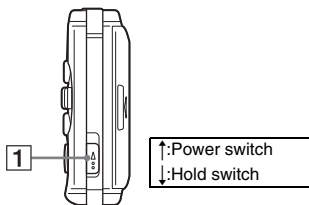

1 Power/hold switch

Turns the system on and off, puts in sleep mode (•▶ pages 29, 31) and locks the system buttons (•▶ page 34)

* The PSP™ system messages use "Memory Stick" as a general reference to Memory Stick Duo™ and Memory Stick PRO Duo™. Note that standard-size Memory Stick™ media cannot be used with the PSP™ system.

Headphones with remote control

Remote control front

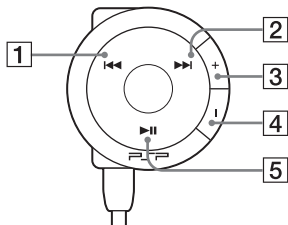

- 1** **◀◀ button**
- 2** **▶▶ button**
- 3** **Volume + button**
Turns the volume up
- 4** **Volume - button**
Turns the volume down
- 5** **▶|| button**

Remote control side

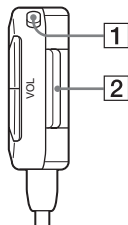

- 1** **Hold switch**
Locks the operation of the remote control. Note that this button does not lock the buttons of the PSP™ system.
- 2** **Clip**

Preparing the PSP™ system for use

Before using the PSP™ system for the first time after purchase, you must follow these steps to charge the battery.

Before inserting the battery pack, find the serial and model numbers listed within the battery compartment and make a record of the numbers in the spaces provided under Owner's Record on page 4.

US

Preparation

Getting started 1: Inserting the battery pack

1 Remove the battery cover.

Hold down the push button and slide the battery cover open.

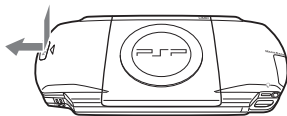

2 Insert the battery pack.

Align the bottom surface of the battery pack with the system to attach.

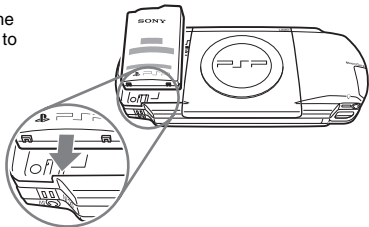

3 Replace the battery cover.

- ② Slide the battery cover in the direction of the arrow until it locks firmly into place.

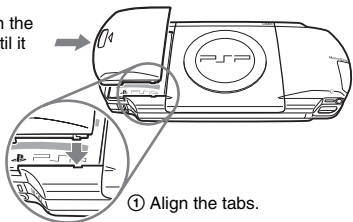

Getting started 2: Charging

Caution

The socket-outlet shall be installed near the equipment and shall be easily accessible.

Do not plug the AC power cord for the PSP™ system into an electrical outlet until you have made all other connections.

1 Plug the AC power cord into the AC adaptor.

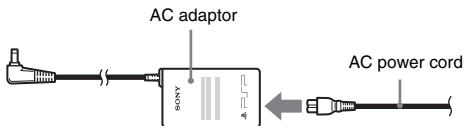

2 Connect the AC adaptor to the DC IN 5V connector on the system bottom.

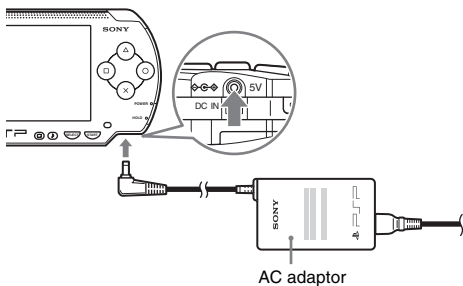

3 Plug the AC power cord into an electrical outlet.

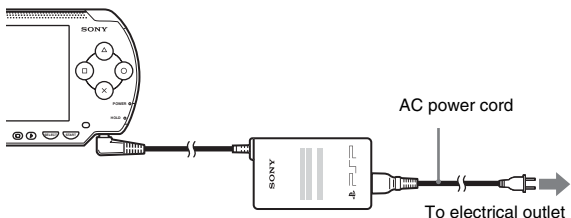

The power indicator lights up in orange, indicating that charging has begun. The power indicator will turn off when the battery is fully charged.

4 Unplug the AC power cord from the electrical outlet and disconnect the AC adaptor from the system.

Hint

For information on how to charge the battery, see "Battery" (➡ page 38).

Getting started 3: Initial setup

1 Turn on the PSP™ system (➡ page 29).

The power indicator lights up in green, and the initial setup screen is displayed.

2 Follow the on-screen instructions to make settings for system language, time zone, date and time and nickname.

When you have completed initial setup, the home menu (➡ page 7) is displayed.

Hints

- See "How to use the keyboard" (➡ page 107) for information on how to enter characters.
- Settings made during initial setup can be changed in  (Settings). See "System Settings" (➡ page 86) and "Date & Time Settings" (➡ page 89) for details.

Connecting the headphones with remote control

1 Connect the headphones to the PSP™ system.

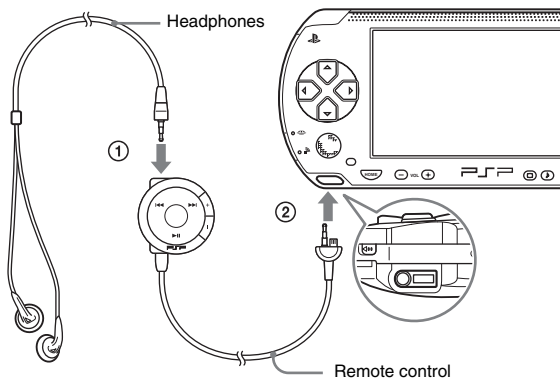

- ① Plug the headphones into the remote control.
- ② Plug the headphones into the headset connector on the system bottom.

Hint

The remote control is exclusively for use with the PSP™ system and cannot be used with other devices. Also, remote controls supplied with other devices cannot be used to operate the PSP™ system.

Turning the PSP™ system on and off

Turning the system on

- 1 Slide the power/hold switch up.

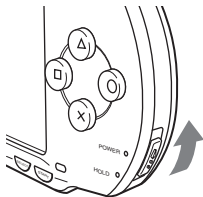

The power indicator lights up in green, and the home menu is displayed.

Hints

- If the PSP™ system is turned on with a UMD™ inserted, the UMD™ will begin playback automatically.
- The system can be used with the AC adaptor connected. In this case, charging will begin automatically. The power indicator lights up in orange while charging.

Power indicator

The color and condition (solid or flashing) of the light indicates system status.

Solid green	Power on
Solid orange	Charging
Flashing green	Charge level is low
Light off	Power off/in sleep mode

Turning the system off

- 1 Hold the power/hold switch in the up position for more than two seconds.**

The power indicator flashes and then turns off, indicating that the system is turned off.

Putting into sleep mode

If the PSP™ system is switched to sleep mode, the game that is playing will be paused. When sleep mode is cleared, the screen that was displayed before entering sleep mode will begin playback again.

Notices

- Do not put the system into sleep mode while the Memory Stick Duo™ access indicator is on. This may cause data loss or corruption.
 - If the battery runs out while in sleep mode, when you clear sleep mode, the system will not return to the screen that was displayed before entering sleep mode. It is recommended that you save game data before you put the system into sleep mode.
-

- 1** With the system turned on, slide the power/hold switch up.

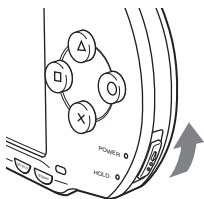

The power indicator flashes and then turns off, and the system enters sleep mode.

Hints

- Some software cannot be put into sleep mode.
- If sleep mode is cleared during video or audio playback, the screen will return to the home menu.

Clearing sleep mode

Slide the power/hold switch up again.

Inserting a UMD™

Notice

Do not eject a UMD™ during playback.

1 Slide the open latch on the PSP™ system top.

The disc cover opens.

2 Insert a UMD™.

With the disc label facing the system rear, slide the UMD™ in the direction of the arrow until it is fully inserted.

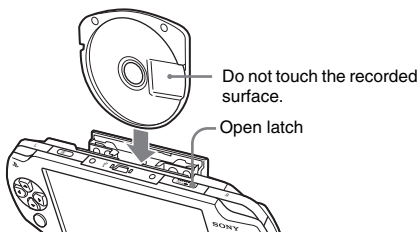

3 Close the disc cover.

Ejecting the UMD™

Slide the open latch on the system top to open the disc cover.

Hint

When ejecting, hold the PSP™ system in an upright position (as shown in the diagram above).

Inserting a Memory Stick Duo™

Warning

Keep Memory Stick Duo™ media out of the reach of small children, as the media could be swallowed by accident.

1 Open the slot cover and insert the Memory Stick Duo™.

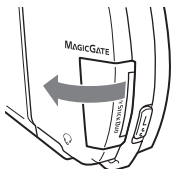

Open the slot cover in the direction of the arrow.

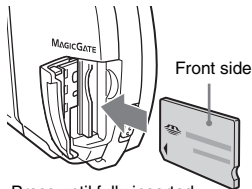

Press until fully inserted.

Ejecting the Memory Stick Duo™

Open the slot cover and press the Memory Stick Duo™ in the direction of the arrow to eject.

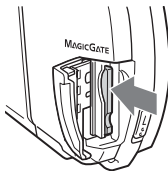

Notice

When the Memory Stick Duo™ access indicator is lit, the PSP™ system is saving or loading data. Do not eject the Memory Stick Duo™, turn off the system or put the PSP™ system into sleep mode while the indicator is lit. If you do, it may cause data loss or corruption.

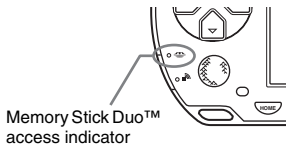

Avoiding unintended operation of the PSP™ system

- 1 Slide the power/hold switch down.**

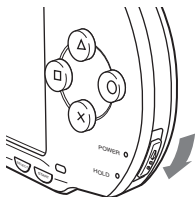

The switch locks into place.

The hold indicator turns yellow, indicating that the system buttons are locked.

Clearing hold mode

Slide the power/hold switch to its original position.

Using the sound button

The sound button is used to adjust the tone and to mute the sound for audio playback and for key tones.

Adjusting the tone

US

1 Press the sound button.

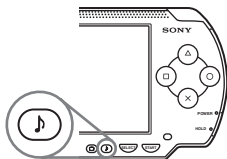

Each time you press the button, the tone changes as follows:

HEAVY	Strengthens both bass and treble to produce an intense sound
POPS	Strengthens the mid-range. Ideal for vocals
JAZZ	Strengthens both bass and treble to produce a balanced sound
UNIQUE	Strengthens bass, treble and mid-range sound
OFF	Normal tone

Hint

Tone can only be adjusted when using the headphones. Also, note that the tone setting is temporarily set to "OFF" during gameplay.

Turning off the sound (mute)

1 Hold down the sound button for more than one second.

The sound will be muted.

Clearing mute

Muting can be turned off by the following methods:

- Pressing the sound button.
- Pressing the volume + or volume - button on the system front or on the remote control.

Using the display button

The display button is used to adjust screen brightness.

Adjusting screen brightness

1 Press the display button.

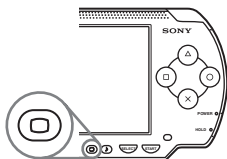

Each time you press the button, the display changes as follows:

Level 1	Darker
Level 2	↓
Level 3	
(Level 4)	Brighter

Hint

Level 4 can be selected only while plugged in using the AC adaptor.

Turning off the backlight

1 Hold down the display button for more than one second.

The backlight will turn off and the screen will go blank.

If you press any of the system buttons, the screen will be displayed again.





Battery

Battery charge level

The battery charge level is displayed on the screen.



Estimating the remaining battery power

	There is plenty of power left.
	The battery is getting low.
	The battery has almost run out.
	No battery power remains. The power indicator flashes green. Recharge the battery.

Hints

- If the power indicator flashes green, save game progress and recharge the battery. If the battery runs out before you save, game progress will be lost.
- The charge level display may vary slightly from the actual charge level, depending on the usage conditions and environmental factors, such as temperature. If the display is not correct, use the battery pack until it is completely out of power and then recharge. Note that the display may not be accurate in the following conditions:
 - if the battery is used for extended periods in conditions of high temperature
 - if the battery is not used for a long time after recharging
 - if the battery has been recharged many times

- Battery charge level can also be checked in "Battery information" under "System Settings" (▶▶▶ page 87).
- If the PSP™ system is left unused after the battery runs out, the date and time settings may be reset. If this occurs, the date and time setting screen will be displayed the next time the system is turned on.
- The battery cannot be recharged when the WLAN feature is in use.

Estimated battery duration

Game	Approximately 3 - 6 hours* ¹
Video playback	Approximately 3 - 5 hours* ²

*1 Based on tests conducted in single player mode, headphones with remote control in use, wireless LAN not in use.

*2 Based on tests conducted using variables of system speakers versus headphones, volume level and screen brightness level.

Hint

Battery duration may vary depending on the type of content being played or usage conditions such as screen brightness and environmental factors. As battery ages, anticipate lower battery duration.

Estimating the battery charge time

It takes approximately 2 hours and 20 minutes to fully charge the batteries using the AC adaptor after the battery has run out.

Hints

- Charge in a temperature of 10°C to 30°C/50°F to 86°F. Charging may not be as effective in other environments.
- Charging may take longer when the system is turned on during charging.

Battery pack life

The battery pack has a limited lifespan. Battery duration will decrease with repeated usage and age. If the battery duration becomes extremely short, it may be time to replace the battery pack.

Hint

The battery pack lifespan varies depending on how it is stored, the conditions of use and environmental factors, such as temperature.

Replacing the battery pack

For safety reasons, turn off the system before replacing the battery pack. Also read "Battery pack precautions" (→ page 17) before handling the battery pack.

Hint

If the system is left unused after the battery pack has been removed, the date and time settings may be reset. If this occurs, the date and time setting screen will be displayed the next time the PSP™ system is turned on.

Storing the battery pack

When the system will not be used for an extended period of time, remove the battery pack from the system. Store the battery pack in a cool, dry place out of the reach of children.

Playing a game



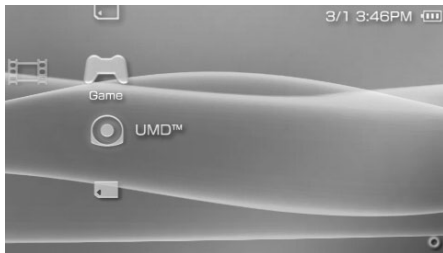

- 1 Select  from the home menu.
- 2 Insert a UMD™ (**▶ page 32).
The UMD™ icon is displayed.







- 3 With the game icon selected, press the  button.
The game starts.

Icons displayed under Game

In addition to playing games, the following features are available under Game.

 Game Sharing	You can play games that support Game Sharing. For details, refer to the software manual supplied with the game.
 Saved Data Utility	You can copy, delete or view information about saved data on a Memory Stick Duo™ (**▶ page 44).
 UMD™	You can play games. If you select the UMD™ icon, the thumbnail for the game is displayed.
 Memory Stick™	You can perform a network update by accessing the update data saved on a Memory Stick Duo™ (**▶ page 104).

Hints

- Access to a game that is displayed as  (Restricted Content) is restricted by the parental control feature. You must enter the password as described below to access the game. See "Parental Control Level" (▶▶ page 94) for details.
 - 1** Select , and then press the .
 - 2** Enter the password using the directional buttons, and then press the  button.
- If you press the home button during gameplay, you can check the remaining battery power.
- Title names and thumbnail images used in this manual are not of actual products.

Quitting a game

- 1 Press the home button while playing a game.**

The message "Do you want to quit the game?" is displayed.
- 2 Select "Yes", and then press the  button.**

The game ends and the home menu is displayed.

Game options menu

You can view game information or copy or delete saved data by displaying the options menu.

1 Select an icon, and then press the \triangle button.

The options menu is displayed.

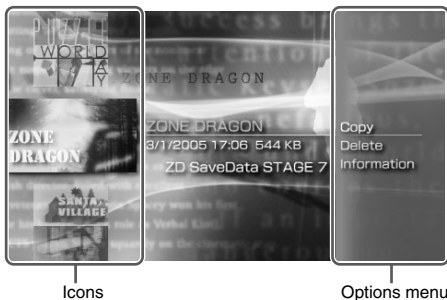

2 Select a menu item, and then press the \otimes button.

Closing the options menu

Press the \triangle button or the \odot button.

List of options

The options menu items available vary depending on the icon selected.





Start	Starts a game
Copy	Copies the saved data on a Memory Stick Duo™ to another Memory Stick Duo™ (**▶ page 44)
Delete	Deletes the saved data on a Memory Stick Duo™ (**▶ page 44)
Information	Displays information about the selected icon

Copying and deleting saved data

You can copy or delete saved game data that is saved on a Memory Stick Duo™ using the saved data utility.

Copying saved data

You can copy saved data to another Memory Stick Duo™. It is recommended that important data be copied as a backup.

- 1** Select , and then press the  button.
- 2** Select the saved data you want to copy, and then press the  button.
The options menu is displayed.
- 3** Select "Copy", and then press the  button.
- 4** Follow the on-screen instructions.

If there is not enough space available

Delete data in the destination Memory Stick Duo™ or replace it with another Memory Stick Duo™. If you display the options menu (➡ page 43), you can delete saved data or check the amount of free space available.

Hint

Depending on the type of Memory Stick Duo™ used, the file size displayed for the same data item may vary.

Deleting saved data

You can delete saved data on a Memory Stick Duo™ by selecting "Delete" in step 3 of "Copying saved data".

Watching a video



You can watch UMD™Video and videos saved on a Memory Stick Duo™. The format (for videos saved on a Memory Stick Duo™) that can be played is MPEG-4 (➡ page 55).

Notice

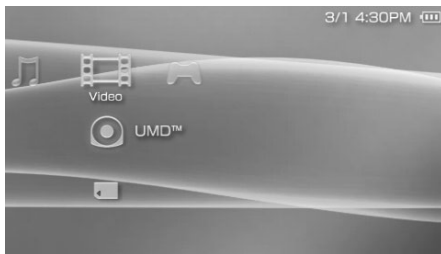

Depending on the UMD™Video, playback conditions may be set in advance by the software developer. In such cases, certain options may not be available, even if you follow the instructions in this manual.

- 1** Select  from the home menu.
- 2** Insert a UMD™ or Memory Stick Duo™ (➡ pages 32, 33).
An icon for the inserted media is displayed.







- 3** Select the icon, and then press the  button.
UMD™Video playback begins. If you select , icons for each video data item will be displayed. Select the video that you want to play, and then press the  button.

Icons displayed under Video

	UMD™	You can play UMD™Video. If you select the icon, a thumbnail for the video is displayed.
	Memory Stick™	You can play video saved on a Memory Stick Duo™.

Hints

- Access to a video that is displayed as  (Restricted Content) is restricted under the parental control feature. Enter the password as described below to access the video. See "Parental Control Level" (▶▶ page 94) for details about the parental control feature.
 - 1 Select , and then press the  button.
 - 2 Using the directional buttons, enter the password, and then press the  button.
- If you press the home button or select button during video playback, the home menu will be shown on the screen while the paused image of the video is displayed. If you press the button again, the home menu is cleared.
- You can adjust the tone or mute the sound using the sound button (▶▶ page 35).

Stopping playback

1 Press the button during video playback.

The video will stop.

Hint

In most cases, the next time you play the video, playback will resume from the previous stopping point.

Playing a video from the beginning

If you want to play a UMD™Video from the beginning, select "Play from Beginning" in the options menu (▶▶ page 54), and then press the  button.

Using the control panel

You can perform the following operations using the on-screen control panel.

1 Press the Δ button during video playback.

The control panel is displayed.



US

Video



2 Select an icon, and then press the \otimes button.

Clearing the control panel

Press the Δ button or the \odot button.

List of operations

The icons displayed when playing a UMD™Video are different from those displayed when playing a video saved on a Memory Stick Duo™.

Icon		Description
	Menu	Displays the UMD™Video menu
	Audio Options	Switches between available audio options for UMD™Video recorded with multiple audio tracks
	Angle Options	Switches between available viewing angles for UMD™Video recorded with multiple angles

Icon		Description
	Subtitle Options	Switches between available subtitle options for UMD™Video that include subtitles
	Go To	Plays video data stored on a Memory Stick Duo™ from a specified time (**▶page 50)
	UMD™ Video Volume	Boosts the volume of the UMD™Video (**▶page 51)
	Screen Mode	Changes the size of the image displayed on the screen (**▶page 50)
	Display	Displays the playback status and related information (**▶page 49)
	Help	Displays the functions that can be performed using the PSP™ system buttons
	Previous	Returns to the previous chapter of a UMD™Video during playback
	Return to Beginning	Returns to the beginning of a video saved on a Memory Stick Duo™ during playback
	Next	Skips to the next chapter*
	Fast Reverse/ Fast Forward	Accelerates playback (reverse or forward) on the screen to help locate a particular scene (**▶page 51)
	Slow Motion	Plays a scene in slow motion (**▶page 51)
	Frame Advance	Plays a scene one frame at a time
	Play	Starts playback
	Pause	Pauses playback
	Stop	Stops playback
	Repeat	Plays the video repeatedly (**▶page 52)

* This operation cannot be performed during playback of video saved on a Memory Stick Duo™.

Icon	Description
CLEAR Clear	Clears the Repeat setting

Viewing playback status and related information

- 1 Select  from the control panel during playback, and then press the  button.

The playback status of the video is displayed.



Clearing display

Select  from the control panel, and then press the  button.

Hint

The items displayed when playing a UMD™ Video are different from those displayed when playing a video saved on a Memory Stick Duo™.

Changing the Screen Mode

Changes the size of the viewable image on the screen.

- 1 Select  from the control panel, and then press the  button.

Each time the  button is pressed, the Screen Mode will change as follows:



Normal	The image is adjusted to fit the PSP™ system's screen size.
Zoom	The image is shown at the full screen size without changing proportions, while cutting off the top and bottom or left and right areas.
Full Screen	The image is shown in the full screen size by changing proportions and zooming in horizontally and vertically.
Original	The image is shown in the original size.

Hint

Depending on the video being played, the Screen Mode may remain unchanged.

Playback from a selected scene

You can play video data stored on a Memory Stick Duo™ starting from a specified time.

- 1 Select  from the control panel, and then press the  button.
- 2 Using the directional buttons, specify a time value, and then press the  button.

Adjusting the UMD™ Video volume

The volume can be adjusted if the audio output level of the UMD™ is low.

- 1 Select  from the control panel, and then press the  button.

Each time you press the  button, the volume will change as follows:

+1	Raises the volume
+2	Raises the volume (maximum)
Normal	Usually select this setting.

Hint

The volume setting will be cleared if the UMD™ is ejected. The volume can be permanently set to a higher level under Video Settings (**▶ page 84).



Fast Reverse/Fast Forward

- 1 During playback, select  or  from the control panel, and then press the  button.

Returning to normal playback

Select  from the control panel, and then press the  button.



Hint

While using Fast Reverse or Fast Forward, select  or  from the control panel, and then press the  button to switch between three speed options.





Slow playback

- 1 During playback, select  from the control panel, and then press the  button.

Returning to normal playback

Select  from the control panel, and then press the  button.

Hint

Selecting  or  from the control panel while playback is paused, and then pressing the , will also start slow playback. If  (Fast Forward) is held down, slow playback will continue only as long as the  button is held.

Playing repeatedly

You can play the entire disc or a chapter repeatedly.

1 Select from the control panel, and then press the button.

Each time you press the , the repeat mode changes as follows:









Disc Repeat	Plays the entire disc repeatedly
Chapter Repeat	Plays the specified chapter repeatedly
Repeat Off	Ends repeat playback

Hints

- You can also stop repeated playback by pressing the  button after selecting **CLEAR** from the control panel.
- The only repeat options for videos saved on a Memory Stick Duo™ are Repeat On and Repeat Off.

Operating with PSP™ system buttons or the remote control

You can operate the PSP™ system without using the control panel by using the system buttons or the remote control.

	System button operation	Remote control operation
Play	Press the  button or start button.	Press the  button.
Pause	Press the start button.	Press the  button.
Displaying the UMD™ menu	Press the  button.*1	–
Stop	Press the  button.	–
Play the previous chapter	Press the L button.*1	Press the  button.*1
Play the next chapter	Press the R button.*1	Press the  button.*1
Fast Reverse	Press the left button.*2	Press and hold the  button.
Fast Forward	Press the right button.*2	Press and hold the  button.
Slow	Press the right button during pause.*2	–

*1 This operation cannot be performed during playback of video saved on a Memory Stick Duo™.

*2 If you press and hold the button, the video will play in Fast Reverse/Fast Forward/Slow as long as the button is held down.

Hint

Some buttons cannot be operated while the control panel is displayed on the screen. In this case, press the  button to clear the control panel.

Video options menu

You can use the Video options menu to play a UMD™Video or view information or delete videos saved on a Memory Stick Duo™.

1 Select the icon, and then press the Δ button.

The options menu is displayed.

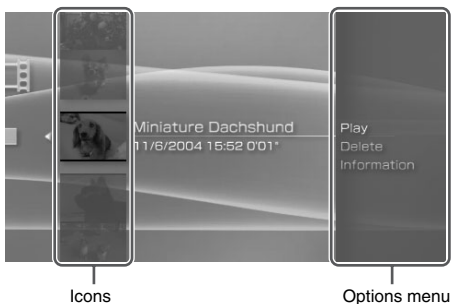

2 Select a menu item, and then press the \otimes button.

Clearing the options menu

Press the Δ button or the \odot button.

Options list

The options menu items available vary depending on the icon selected.

Play	Plays a UMD™Video or a video saved on a Memory Stick Duo™
Play from Beginning	Plays a UMD™Video from the beginning
Delete	Deletes a video saved on a Memory Stick Duo™
Information	Displays information about the selected icon

Saving videos on a Memory Stick Duo™

The following methods can be used to save a video on a Memory Stick Duo™.

Images or video recorded with a device that is compatible with MPEG-4

When using an MPEG-4-compatible device, you can play motion video by directly inserting the compatible device's Memory Stick Duo™ into the PSP™ system.

- * The only MPEG-4 files that can be played with the PSP™ system are MP4 format files that conform with the Memory Stick™ video format.
Visit <http://www.memorystick.com/psp> for more information about compatible devices.

Hint

A Memory Stick Duo Adaptor (model number MSAC-M2: a Sony product sold separately) is required if your MPEG-4-compatible device can handle only a standard-size Memory Stick™.

US

Video

Transferring a video file from a PC to a Memory Stick Duo™

You can convert motion video that was taken or recorded on another device into a format that can be played on the PSP™ system and transfer it to a Memory Stick Duo™ using compatible software (release date to be determined)*.

* For up-to-date information on software release dates, see <http://www.memorystick.com/psp>

Files can be transferred using any of the following methods:

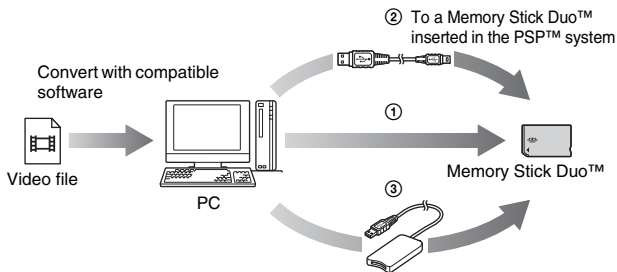

- ① Use a PC with a Memory Stick™ slot.
- ② Use a commercially available USB cable (→ page 96).
- ③ Use a commercially available Memory Stick USB reader/writer.*

* If the device can handle only the standard-size Memory Stick™, you will need a Memory Stick Duo Adaptor (model number MSAC-M2: a Sony product sold separately).

Hints



- See <http://www.memorystick.com/psp> for information on the formats that can be converted.
- The PSP™ system cannot play video data converted at bit rates higher than 768 kbps.

Listening to music

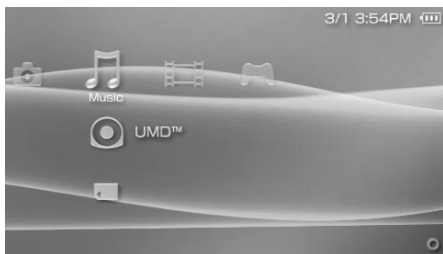

You can listen to UMD™Audio and music saved on a Memory Stick Duo™. The file formats (for music saved on Memory Stick Duo™) that can be played are ATRAC3plus™ and MP3 (→ page 67).

- 1** Select  from the home menu.
- 2** Insert a UMD™ or a Memory Stick Duo™ (→ pages 32, 33).
An icon for the inserted media is displayed.



- 3** Select the icon, and then press the  button.
The group or track list will be displayed. Select a track you want to listen to, and then press the  button.

Icons displayed under Music

 UMD™	You can play UMD™Audio. If you select the icon a thumbnail for the music is displayed.
 Memory Stick™	You can play music saved on a Memory Stick Duo™.

Hints

- If the start button or the ►|| button on the remote control is pressed in step 3, the first track of the first group will begin playing.
- If the home button or select button is pressed during playback, the screen will return to the home menu. If the button is pressed again, the music playback screen will be displayed.
- You can adjust the tone or mute the sound using the sound button (**► page 35).
- Title names and thumbnail images used in this manual are not of actual products.

What is a Group?

A group is a collection of music data arranged in a certain order, such as by album or by artist. When Group Mode is turned on, the PSP™ system can play tracks in groups that were configured using a PC.

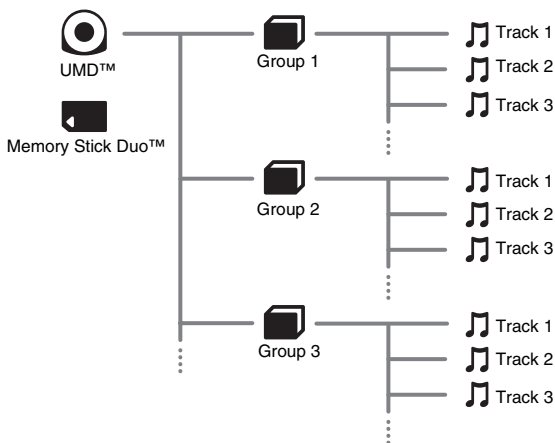

Hints

- The PSP™ system cannot be used to create or edit a group.
- "Track" represents a song.

Stopping playback

1 Press the button during playback.

Playback stops.

How to read the screen

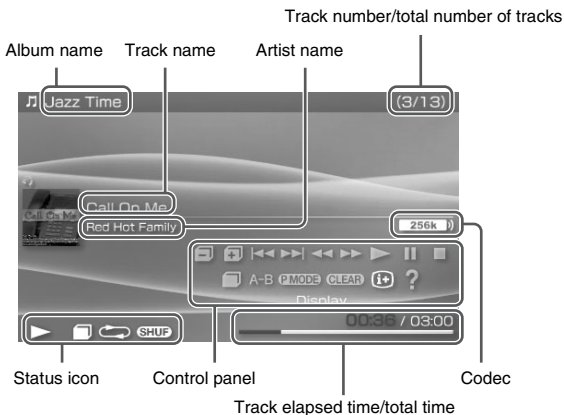

Hints

- "Album name" and "Track number/total number of tracks" are shown on the screen only while  (Display) is turned on (➡ page 61).
- The icon or icons displayed in the "Status icon" field will vary depending on the playback mode selected.
- See "Playing with a selected codec" (➡ page 66) for details about codecs.

US

Music

Using the control panel

You can perform the following operations using the on-screen control panel.

1 Press the \triangle button during playback.

The control panel is displayed.









2 Select an icon, and then press the \otimes button.

Clearing the control panel

Press the \triangle button or the \odot button.

List of operations

Icon		Description
	Previous Group	Returns to the beginning of the previous group
	Next Group	Skips to the beginning of the next group
	Previous Track	Returns to the beginning of the track currently playing or to the beginning of the previous track
	Next Track	Skips to the beginning of the next track

Icon		Description
	Fast Reverse/ Fast Forward	Plays in fast reverse/fast forward*
	Play	Plays a track
	Pause	Pauses playback
	Stop	Stops playback
	Group Mode	Switches to Group Mode (**▶ page 61)
A-B	A-B Repeat	Specifies a part of a track, and then plays that part repeatedly (**▶ page 63)
P MODE	Play Mode	Switches to Play Mode (**▶ page 62)
CLEAR	Clear	Clears Group Mode, Play Mode and A-B Repeat settings
	Display	Displays album name, track number and total number of tracks
	Help	Displays the functions that can be performed using the system buttons

* If you press and hold the  button, the music will play in Fast Reverse/Fast Forward as long as the button is held down.



Using Group Mode

Tracks can be played in groups. Playback stops after all tracks in the group have been played.

- 1 During playback, select  from the control panel, and then press the .**

Group Mode is turned on, and then  is displayed on the screen.





Clearing Group Mode

While Group Mode is on, select  from the control panel, and then press the  button.

Using Play Modes (Repeat/Shuffle)



1 During playback, select from the control panel, and then press the button.

Each time the  button is pressed, the system switches between the following functions:

Play Mode	Description
	Plays a track repeatedly
	Plays all tracks repeatedly
	Plays all tracks in a random order*
	Plays all tracks in a random order repeatedly
No icon	Clears Play Mode and plays through to the last track in normal order

* If there is a group, tracks in the group are played in a random order. The order of the groups will not change.

Hint

Play Modes can also be cleared by selecting  from the control panel, and then pressing the  button.

Playing part of a track repeatedly (A-B Repeat) A-B

Specify and then play the part that you want to play repeatedly.

- 1 Select A-B from the control panel during playback, and then press the (X) button at the point where you want the repeated playback to begin.**

The starting point (point A) is set.

- 2 Press the (X) button at the point where you want the repeated playback to end.**

The ending point (point B) is set, and repeated playback of the specified section begins.

Clearing A-B Repeat









Select A-B or **CLEAR** from the control panel, and then press the (X) button. The specified part is cleared, and normal playback resumes.

Hints

- The range for A-B Repeat can only be specified within a single track.
- If the ending point (point B) is not set, the end of the track will automatically become the ending point (point B).
- If A-B Repeat is set while in a Play Mode, the Play Mode will be cleared.

Operating with PSP™ system buttons or the remote control

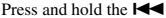
You can operate the PSP™ system without using the control panel by using the system buttons or the remote control.

	System button operation	Remote control operation
Play	Press the  button or start button.	Press the  button.
Pause	Press the start button.	Press the  button.
Stop	Press the  button.	—
Skip to the beginning of the current track or the previous track	Press the L button.	Press the  button. Or, press the  button as many times as the number of tracks you want to go back.
Skip to the beginning of the next track	Press the R button.	Press the  button.
Fast Reverse	Press the left button.*	Press and hold the  button.
Fast Forward	Press the right button.*	Press and hold the  button.

* If you press and hold the button, the music will play in Fast Reverse/Fast Forward as long as the button is held down.

Hint

Some buttons cannot be operated while the control panel is displayed on the screen. In this case, press the  button to clear the control panel.

Music options menu

You can use the Music options menu to view information about or delete music data saved on a Memory Stick Duo™.

1 Select an icon, and then press the Δ button.

The options menu is displayed.

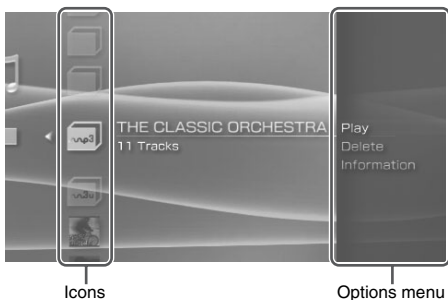

2 Select a menu item, and then press the \otimes button.

Clearing the options menu

Press the Δ button or the \odot button.



Options list



The options menu items available vary depending on the icon selected.

Play	Plays UMD™Audio or music data saved on a Memory Stick Duo™
Select Codec	Sets a file format or bit rate for music playback (**► page 66)
Delete	Deletes music data saved on a Memory Stick Duo™
Information	Displays information about the selected icon

Playing with a selected codec

With a UMD™Audio that has multiple file formats and bit rates recorded, you can select from among these options for playback.

- 1 Select a group you want to listen to, and then press the  button.**
- 2 Select "Select Codec", and then press the  button.**

The types of file formats and bit rates are displayed. The items displayed in gray cannot be selected because they are of types that cannot be played on the system.
- 3 Select the type of file format and bit rate that you want to listen to, and then press the  button.**
- 4 Press the  button.**

The icons for groups are displayed.
- 5 After selecting a group, select the track you want to listen to, and then press the  button.**

Playback begins.

Hint

Items such as "ATRAC3plus™" represent the type of file format, while items such as "256 kbps" represent the bit rate. As a general rule, the higher the bit rate, the better the sound quality. See "Formats that can be played" (•► page 112) for details about file formats.

Transferring and saving music on a Memory Stick Duo™

You can use the PSP™ system to play music data obtained in the following ways:

- 1) Music imported from an audio CD.
- 2) Music purchased from a music download Web site.

See below for instructions regarding item 1).

See <http://www.memorystick.com/psp> for instructions regarding item 2).

US

Music

Importing tracks from an audio CD in ATRAC3plus™ format

A PC and software (release date to be determined*) that supports ATRAC3plus™ are required to import tracks from an audio CD. ATRAC3plus™ data cannot be played or recorded using a Memory Stick PRO Duo™. Use any Memory Stick Duo™ that supports MagicGate™ other than Memory Stick PRO Duo™ (**▶ page 110).

* For up-to-date information on software release dates, see <http://www.memorystick.com/psp>

You can transfer the imported tracks to a Memory Stick Duo™ using either of the following methods:

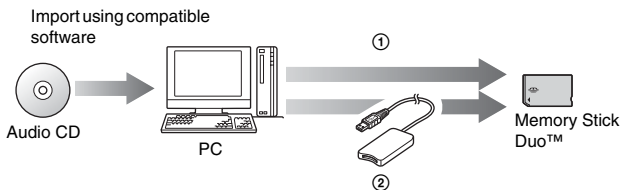

- ① Use a PC with a Memory Stick™ slot that supports MagicGate™.*1
- ② Use a commercially available Memory Stick USB reader/writer.*1*2

- *1 If the slot on the device can handle only standard-size Memory Stick™ media, a Memory Stick Duo Adaptor (model number MSAC-M2: a Sony product sold separately) is required.
- *2 A device that supports MagicGate™ such as model number MSAC-US30 (a Sony product sold separately) is required.

Hints

- For detailed information about importing tracks, see <http://www.memorystick.com/psp>
- The PSP™ system cannot play tracks that have a limitation of playback period or a limited count of playbacks.

Importing tracks from an audio CD in MP3 format

A PC and software that is compatible with the MP3 format are required to import tracks from an audio CD.

You can save imported tracks on a Memory Stick Duo™ using any of the following methods:

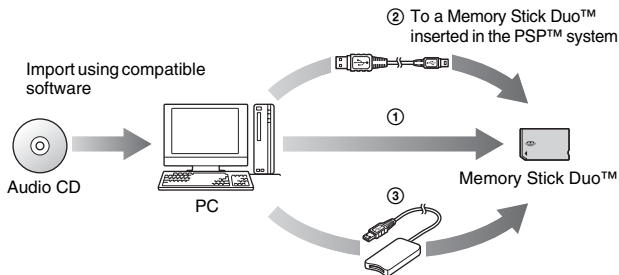

- ① Use a PC with a Memory Stick™ slot.*
- ② Use a commercially available USB cable (➡ page 96).
- ③ Use a commercially available Memory Stick USB reader/writer.*

* If the slot on the device can handle only standard-size Memory Stick™ media, a Memory Stick Duo Adaptor (model number MSAC-M2: a Sony product sold separately) is required.

Hint

The method of importing tracks varies depending on the software. For details, refer to the instructions supplied with the software.



Where to save music data

Create a folder named "PSP" directly on the Memory Stick Duo™, and then create a folder named "MUSIC"* in the "PSP" folder. Save MP3 data in the "MUSIC" folder. The PSP™ system will not recognize data items saved anywhere other than in this folder.

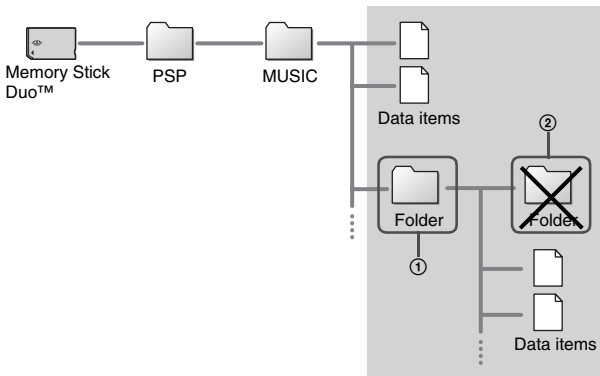
* The folder name does not need to be all capital letters.





Hints



- If a folder named "PSP" has already been created on the Memory Stick Duo™, create a "MUSIC" folder within it.
- You can create folders within the "MUSIC" folder (Figure ①). The system will display each created folder as an  (MP3) icon, and treats it as a group.
- Folders created within sub-folders will not be recognized (Figure ②).
- If you want to specify the order of the tracks, create an m3u file specifying the order in the folder. The system will display the file as an  (m3u) icon, and treat it as a group.
- If a file that is not an MP3 file is saved in the "MUSIC" folder, the system will not recognize it.

Viewing images

You can view images saved on a Memory Stick Duo™. The file format that can be displayed is JPEG (→ page 80).

- 1 Select  from the home menu.
- 2 Insert a Memory Stick Duo™ (→ page 33).
 is displayed.



- 3 Press the  button while  is selected. Icons for Digital Camera Images, folders and images saved on the Memory Stick Duo™ are displayed. Select the icon that you want to display, and then press the  button.

Icons displayed under Photo

 Memory Stick™	You can view images saved on a Memory Stick Duo™.
---	---

Hint

If you press the home button or select button while displaying an image, the screen will return to the home menu while continuing to display the image. If you press the button again, the screen will return to the image display screen.

Using the control panel

You can perform the following operations using the on-screen control panel.

1 Press the Δ button while displaying an image.

The control panel is displayed.

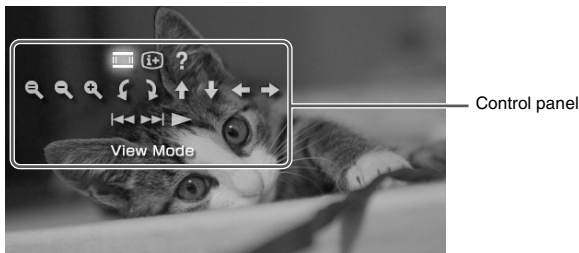









2 Select an icon, and then press the \otimes button.

Clearing the control panel



Press the Δ button or the \odot button.

List of operations

Icon		Description
	View Mode	Changes the size of the image displayed (▶▶ page 73)
	Display	Displays information about the image (▶▶ page 72)
	Help	Displays the functions that can be performed using the PSP™ system buttons
	Clear Zoom	Returns an image that has been zoomed in or out on to its original size

Icon		Description
	Zoom Out	Zooms out from the image
	Zoom In	Zooms in on the image
	Rotate Left	Rotates the image 90-degrees counterclockwise
	Rotate Right	Rotates the image 90-degrees clockwise
	Up/Down/Left/Right	Moves the image up, down, left or right to display any obscured part when the image has been zoomed in or out on, or when the View Mode is set to Zoom
	Previous	Displays the previous image
	Next	Displays the next image
	Slideshow	Automatically displays each image in order (▶▶ page 76)

Displaying image information

- 1 While displaying an image, select  from the control panel, and then press the  button.

The image status is displayed.

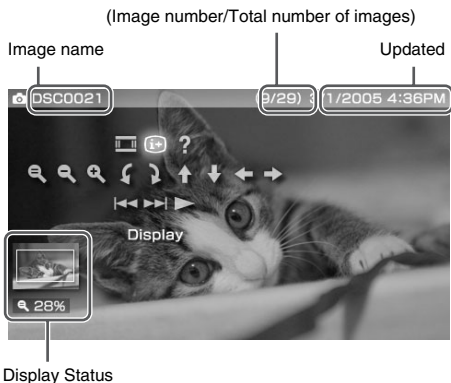

Clearing the display

Select **(i+)** from the control panel, and then press the **(X)** button.

Adjusting image size

You can change the size of the image displayed on the screen.

- 1 While displaying the image, select  from the control panel, and then press the **(X)** button.**

Each time you press the button, the option switches as follows:

Normal	Displays the image to fit the screen size without changing proportions
Zoom	Displays the image at the full screen size without changing proportions. Portions of the image at the top and bottom or left and right are cut off.

Hint

Depending on the image being displayed, the View Mode may not change.

Operating with PSP™ system buttons or the remote control

You can operate the PSP™ system without using the control panel by using the system buttons or the remote control.

	System button operation	Remote control operation
Play a slideshow	Press the start button.	Press the ►► button.
Cancel zoom in/out	Press the ⊗ button when the image has been zoomed in or out.	—
Back	Press the ⊙ button.	—
Display the previous image	Press the L button.	Press the ◀◀ button.
Display the next image	Press the R button.	Press the ▶▶ button.
Zoom in	Move the analog stick up while holding down the ⊕ button.	—
Zoom out	Move the analog stick down while holding down the ⊖ button.	—
Rotate (Left)	Press the L button while holding down the ⊕ button.	—
Rotate (Right)	Press the R button while holding down the ⊕ button.	—
Move*	Move the analog stick.	—

* Obscured parts of the image are displayed when zooming in/out, or when the View Mode is set to Zoom.

Hint

Some buttons cannot be operated while the control panel is displayed on the screen. In this case, press the ▲ button to clear the control panel.

Photo options menu

When the Photo options menu is displayed, you can view information about or delete images saved on a Memory Stick Duo™.

1 Select an icon and then press the Δ button.

The options menu is displayed.

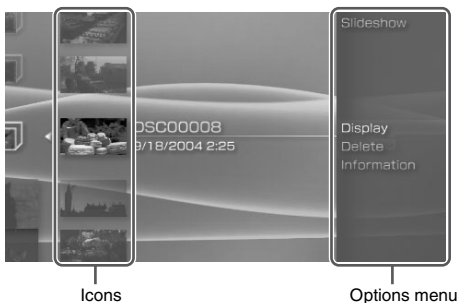

2 Select a menu item, and then press the \otimes button.

Clearing the options menu

Press the Δ button or the \odot button.

Options list

The options menu items available vary depending on the icon selected.

Slideshow	Automatically displays each image in order (**▶ page 76)
Display	Displays images
Delete	Deletes folders or images
Information	Displays information about the selected icon

Playing slideshows

You can set the available images to be displayed in order.

1 Select the icon for a folder or media containing images, and then press the start button.

The slideshow begins. The content displayed varies depending on the icon selected.

Icon	Description
Memory Stick™	All images saved on a Memory Stick Duo™ are displayed in order.
Digital Camera Images	All images in the Digital Camera Images folder are displayed in order.
Folder	All images in the selected folder are displayed in order.
Images	Images are displayed in order, starting from the selected image.

Stopping a slideshow

Press the  button.

Hints

- The display speed of the images can be adjusted. See "Photo Settings" (➡ page 85) for details.
- The slideshow can also be started in the following ways:
 - From the options menu (➡ page 75).
 - From the image control panel (➡ page 71).

Using the control panel

1 Press the button during the slideshow.

The control panel is displayed.

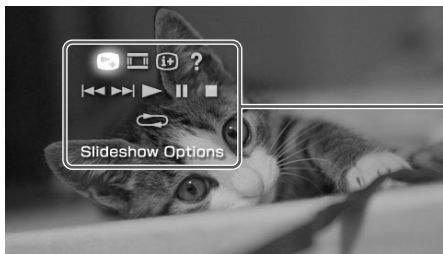

Control panel

2 Select an icon, and then press the \otimes button.

Clearing the control panel

Press the \triangle button or the \odot button.

List of Operations

Icon		Description
	Slideshow Options	Switches the information displayed on the screen (→▶ page 78)
	View Mode	Changes the size of the image displayed on the screen
	Display	Displays image information
	Help	Displays the functions that can be performed using the PSP™ system buttons
	Previous	Displays the previous image
	Next	Displays the next image
	Play	Starts the slideshow
	Pause	Pauses the slideshow
	Stop	Stops the slideshow

Icon	Description
 Repeat	Plays the slideshow repeatedly

Displaying slideshow options





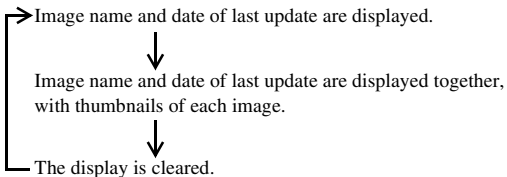

- 1** During a slideshow, select  from the control panel, and then press the  button.

Each time you press the  button, the option switches as follows:



Operating with PSP™ system buttons or the remote control

You can operate the PSP™ system without using the control panel by using the system buttons or remote control.

	System button operation	Remote control operation
Playing a slideshow	Press the start button.	Press the  button.
Pausing a slideshow	Press the start button.	Press the  button.
Stopping a slideshow	Press the  button.	-
Displaying the previous image	Press the L button.	Press the  button.
Displaying the next image	Press the R button.	Press the  button.
Displaying slideshow options	Press the  button.	-

Hint

Some buttons cannot be operated while the control panel is displayed on the screen. In this case, press the  button to clear the control panel.

Saving images on a Memory Stick Duo™

You can save images on a Memory Stick Duo™ by the methods described below.

Taking photos using a digital still camera

When using a digital still camera that is compatible with the Memory Stick Duo™, photos can be displayed by inserting the Memory Stick Duo™ from the camera directly into the PSP™ system. Photos on the Memory Stick Duo™ will be displayed in the system's "Digital Camera Images" folder.

Hint

You can use Memory Stick Duo™ media with a digital still camera that can handle only the standard-size Memory Stick™ by using a Memory Stick Duo Adaptor (model number MSAC-M2: a Sony product sold separately).

Saving image data items from a PC to a Memory Stick Duo™

You can save images using any of the following methods:

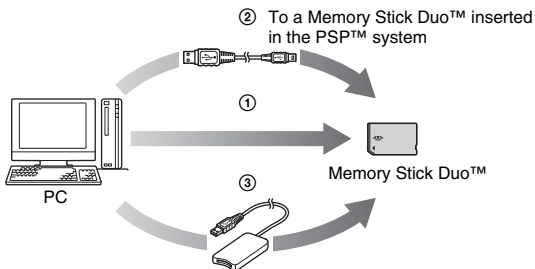

- ① Using a PC with a Memory Stick™ slot.*
- ② Using a commercially available USB cable (**▶ page 96).
- ③ Using a commercially available Memory Stick USB reader/writer.*

* A Memory Stick Duo Adaptor (model number MSAC-M2: a Sony product sold separately) is required if the slot on the device you are using is able to handle only the standard-size Memory Stick™.

Where to save image data

Create a folder named "PSP" directly on the Memory Stick Duo™, and then create a folder named "PHOTO"* in the "PSP" folder. Save image data in the "PHOTO" folder. The PSP™ system will not recognize data items saved anywhere other than in this folder.

* The folder name does not need to be all capital letters.

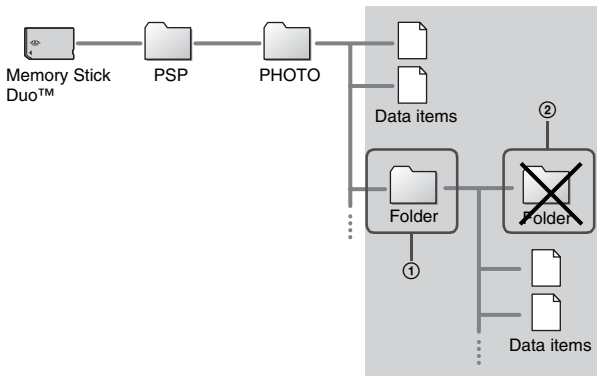

Hints

- If a folder named "PSP" has already been created on the Memory Stick Duo™, create a "PHOTO" folder within it.
- You can create folders within the "PHOTO" folder (Figure ①).
- Folders created within sub-folders will not be recognized (Figure ②).
- It may not be possible to display some images, depending on the size of the image data.
- Images edited using a PC may not be viewable on the PSP™ system.

Settings for the PSP™ system

You can adjust the settings for the PSP™ system, as well as settings for features, such as video, photo and network.

1 Select from the home menu.











Icons for various settings are displayed.



2 Select an icon, and then press the button.

A setting screen for the icon is displayed. For details, see the instructions for each setting (▶▶ pages 83-106).

Icons displayed under Settings

	Network Update	Provides access to updates for the system software (**▶ page 104)
	USB Connection	Allows for connection to a PC using a commercially available USB cable (**▶ page 96)
	Video Settings	Includes settings for UMD™ Video Menu Language, Audio Language and Subtitle Language (**▶ page 84)
	Photo Settings	Includes settings for adjusting the slideshow speed (**▶ page 85)
	System Settings	Includes settings for the System Language and Nickname, and provides an option to format Memory Stick Duo™ media (**▶ page 86)
	Date & Time Settings	Allows the user to set the date and time, as well as adjust for daylight saving time (**▶ page 89)
	Power Save Settings	Includes settings to automatically turn off the backlight and put the system in sleep mode (**▶ page 90)
	Sound Settings	Provides access to settings for AVLS (Automatic Volume Limiter System) and Key Tone (**▶ page 92)
	Security Settings	Allows the user to change the password and adjust the level setting for the parental control feature (**▶ page 93)
	Network Settings	Provides access to settings for connecting to a wireless local area network (WLAN) (**▶ page 98)

Video Settings

You can set the UMD™Video language or boost UMD™Video volume.

Notice

Depending on the UMD™Video, playback conditions may be set in advance by the software developer. In such cases, certain options may not be available, even if you follow the instructions in this manual.

Menu Language	Select a language for the UMD™Video menu.
Audio Language	Select a language for the audio.
Subtitle Language	Select a language for subtitles.
UMD™ Video Volume	Adjust the volume when UMD™Video output level is low. The volume increases in the following order: "Normal", "+1" and "+2".

Hint

The settings at the time of purchase are as follows:

- "Menu Language" and "Subtitle Language" are set to "English".
- "Audio Language" is set to "Original Language".
- "UMD™ Video Volume" is set to "Normal".

Photo Settings

You can set the Slideshow Speed.

Fast	Displays images at a faster rate
<u>Normal</u>	Displays images at normal speed
Slow	Displays images at a slower rate

The default setting for the menu item is underlined.

System Settings

You can adjust the settings for and display information about the PSP™ system, or format a Memory Stick Duo™.

Nickname

The nickname you selected in the initial setup can be changed. Use the on-screen keyboard to enter a new nickname. For details on keyboard operation, see "How to use the keyboard" (▶▶ page 107).

System Language

Sets the language for system menus, such as the home menu.

Deutsch	Displays messages in German
<u>English</u>	Displays messages in English
Español	Displays messages in Spanish
Français	Displays messages in French
Italiano	Displays messages in Italian
Nederlands	Displays messages in Dutch
Português	Displays messages in Portuguese
Русский	Displays messages in Russian
日本語	Displays messages in Japanese

The default setting for the menu item is underlined.

Battery Information

You can display the following information about the system battery:

Charge Level	Displays the battery charge level as a percentage
Hours Left*	Displays the remaining hours of battery duration (except when charging)
Power Source	Displays the current source of power: "External" or "Battery"
Battery Status	Displays the status of the battery: "In Use", "Charging" or "Charge Complete"

* The number of hours as calculated by the system is shown as an estimate.

Hint

There may be a slight difference between the display information and actual battery performance. This is due to variations in actual usage conditions and environmental factors (such as temperature).

Format Memory Stick™

You can format Memory Stick Duo™ media using the system. Follow the on-screen instructions to perform this operation.

Notice

When you format, all software and data stored on the Memory Stick Duo™ will be deleted and cannot be recovered. Be careful not to accidentally erase important data.

Restore Default Settings

The settings at the time of purchase can be restored. Follow the on-screen instructions to perform this operation.

Notice

When the default settings are restored, the current settings will be lost and cannot be recovered.

System Information

You can display information about the PSP™ system.

MAC Address	Displays the system's MAC address
System Software	Displays the version of the system software
Nickname	Displays the system nickname

About PSP™

Displays trademark and copyright information related to software used by the PSP™ system.

Date & Time Settings

You can set the date and time, daylight saving time and time zone for the PSP™ system. Set each item using the directional buttons and enter the setting by pressing the (X) button.

Date and Time	Sets the year, month, day, hour, minute and second (and AM/PM setting if using a 12-hour time format)
Date Format	Sets the order of year, month and day displayed on the screen
Time Format	Sets to use the 12-hour or 24-hour display format
Time Zone	Sets the appropriate time zone
Daylight Saving	Selects either "Standard" or "Daylight Saving" (Standard is the default)

Hints

- When the time zone is changed, the date and time settings are automatically adjusted based on the time difference between the old and new time zones.
- The PSP™ system's background color changes from month to month. If you change the month setting under "Date & Time Settings", the background color will change automatically.

Power Save Settings

You can conserve the power of the PSP™ system by setting the system to automatically go into sleep mode or switch off the backlight.

Backlight Auto-Off

When the system remains idle for a certain period of time, it saves power by automatically turning off the backlight on the LCD screen. When the backlight is turned off, the screen goes blank.

Off	The backlight does not turn off automatically.
2 minutes	Turns the screen darker after one minute and turns off the backlight after another minute
<u>5 minutes</u>	Turns the screen darker after one minute and turns off the backlight after four more minutes
10 minutes	Turns the screen darker after one minute and turns off the backlight after nine more minutes

The default setting for the menu item is underlined.

Turning on the backlight

When the backlight is turned off automatically, press any of the system buttons to turn it back on.

Hint

The Backlight Auto-Off feature may not work during the following operations:

- During video playback
- While playing a slideshow

Auto Sleep

You can set the system to conserve power by automatically entering sleep mode when it remains idle for a certain period of time.

Off	The system does not automatically go into sleep mode.
5 minutes	Enters sleep mode after five minutes
<u>10 minutes</u>	Enters sleep mode after ten minutes
15 minutes	Enters sleep mode after fifteen minutes

The default setting for the menu item is underlined.

Clearing sleep mode

Slide the power/hold switch on the right side of the system up.

Hint

The Auto Sleep feature may not work during the following operations:

- When connected using the AC adaptor
- While playing a game
- During video playback
- During music playback
- While playing a slideshow

WLAN Power Save

You can switch the power mode of the wireless networking feature. If you select "Off", the system will communicate at full power.

Off	Communications set to maximum power
<u>On</u>	Communications set to power-save mode

The default setting for the menu item is underlined.

Notice

Because setting the power-save mode to "Off" will cause the battery to run out more quickly, it is best to leave it set to "On" during normal usage.

Sound Settings

You can turn off the key tone and limit the volume level.

AVLS (Automatic Volume Limiter System)

You can limit the maximum volume. This can help prevent sound escaping from the headphones, as well as the possible danger resulting from being unable to hear what is going on around you when wearing headphones.

<u>Off</u>	Does not set a limit; allows for the volume to be adjusted manually
On	Sets a limit on the volume

The default setting for the menu item is underlined.

Key Tone

You can turn off the key tone (the confirmation sound made when you press a button).

Off	Does not make a confirmation sound
<u>On</u>	Makes a confirmation sound

The default setting for the menu item is underlined.







You can adjust settings related to PSP™ system security features.

Change Password

Changes the 4-digit password required for the "Parental Control Level" feature. The password is required for the following operations:

- To change the Parental Control Level setting.
- To play a UMD™ that is restricted by the system's Parental Control Level setting.
- To change the password.

Change Password

- 1** Select  (Security Settings) under  from the home menu, and then press the  button.
- 2** Select "Change Password", and then press the  button.
The password entry screen is displayed.
- 3** Using the directional buttons, enter the current 4-digit password, and then press the  button.
When changing the password for the first time after purchase, you must enter "0000".
- 4** Using the directional buttons, enter a new 4-digit password, and then press the  button.
- 5** Select "Yes", and then press the  button.
The password is changed.

Hint

Make a record of your password for future reference.

Parental Control Level

Some UMD™ software have a preset parental control level based on the content. You can set the parental control level on the system to restrict the playback of a UMD™ with a level that is higher than that set on the system.

Parental Control Level

The parental control level of the system can be either turned off or set to one of 11 different levels.

<u>Off</u>	Turns off parental control
11-1	Sets the level of content to be restricted. A setting of "1" is the most restrictive; "11" is the least restrictive.

The default setting for the menu item is underlined.

The combination of the parental control levels of both the PSP™ system and the UMD™ determine whether a UMD™ can be viewed or not. The combination of the two levels is displayed in the table on page 95.

Example: If the parental control level of the system is set to "5", a UMD™ with a level from "1" to "5" can be played on the system.

		UMD™ parental control level										
		1	2	3	4	5	6	7	8	9	10	11
System parental control level	11	1	2	3	4	5	6	7	8	9	10	11
	10	1	2	3	4	5	6	7	8	9	10	11
	9	1	2	3	4	5	6	7	8	9	10	11
	8	1	2	3	4	5	6	7	8	9	10	11
	7	1	2	3	4	5	6	7	8	9	10	11
	6	1	2	3	4	5	6	7	8	9	10	11
	5	1	2	3	4	5	6	7	8	9	10	11
	4	1	2	3	4	5	6	7	8	9	10	11
	3	1	2	3	4	5	6	7	8	9	10	11
	2	1	2	3	4	5	6	7	8	9	10	11
	1	1	2	3	4	5	6	7	8	9	10	11



:The UMD™ can be viewed.



:The UMD™ cannot be viewed.

Parental control levels on games

Most game packaging shows a symbol to indicate the age group that is appropriate to play the game. The symbols correspond to the UMD™ parental control level as shown below:

Age group						
UMD™ parental control level	2	3	4	5	9	10

As of March 2005. For the latest information about ratings, visit our Web site at <http://www.us.playstation.com/psp>

Hints

- The parental control level of a UMD™ can be checked under "Information" in the UMD™ options menu. For a UMD™ that does not include a parental control level, the "Parental Control Level" item under "Information" will display "-".
- A UMD™ that has been restricted by the parental control feature is displayed as (Restricted Content).
- Adults Only or AO ratings are rare. PlayStation® does not publish Adults Only games.

USB Connection ↔ ..

You can transfer files from a PC to a Memory Stick Duo™ inserted in the PSP™ system using a commercially available USB cable. Note however that files that can be played are limited to file formats supported by the system.

USB cables that can be used with the PSP™ system

A USB cable compatible with the Mini-B type connector is required to connect to the system.

Hint

You can connect to a PC with an operating system that supports the USB mass storage class, such as Windows® XP or Mac OS X.

Connecting the system and a PC using a USB cable

You can connect a USB cable to the system and the PC without turning off the power.

1 Connect a USB cable to the system and a PC.

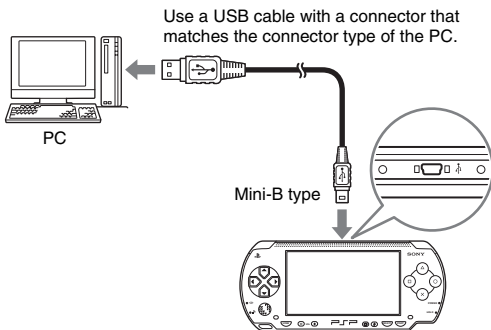

2 Select (USB Connection) under from the home menu, and then press the button.

The Memory Stick Duo™ inserted in the system is detected by the PC.

Notice

Do not format a Memory Stick Duo™ on a PC, as it may no longer be recognized by the PSP™ system.

Network Settings

You can adjust the network settings to allow connection to a wireless local area network (WLAN). There are two WLAN modes.

Warning

Turn off the WLAN switch when in crowded places, such as in a crowded train. If a person nearby is using a pacemaker, it is possible that the radio waves could affect the pacemaker.

Ad Hoc Mode

In this mode, you can communicate directly with other PSP™ systems. To establish a connection in ad hoc mode, both PSP™ systems must either be set to "Automatic" or to the same channel. For details, refer to the instructions supplied with the ad hoc mode-compatible software.

Communication with other PSP™ systems over a WLAN



<u>Automatic</u>	Automatically switches to the optimum channel for communication
Ch 1, Ch 6 or Ch 11	Communicates using the specified channel

The default setting for the menu item is underlined.

Infrastructure mode

In this mode, you can connect the PSP™ system to a network via a WLAN access point.

This is used for features such as Network Update (•▶ page 104).

Required items

The following items are generally required to set up the system to connect to a network and perform a network update.

- Subscription to an Internet service provider
- A network device, such as a DSL or cable modem
- A WLAN access point or a wireless broadband router
- A PC
- Settings used for the SSID, WEP encryption and WEP key, as specified when the wireless access point was configured

Hints

- A WLAN access point is a device used to connect to a wireless network.
- SSID and WEP keys are types of wireless network information. They may be required when connecting to an access point or a router. This information is generally set in the access point or router using a PC. For details, refer to the instructions supplied with the access point or router.





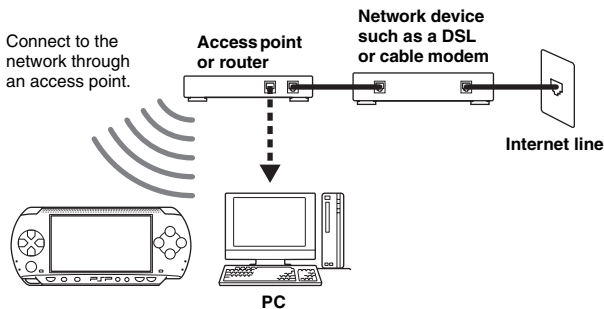

Example of a network configuration

Network equipment connections and setup methods vary depending on the equipment used.



Creating a new network connection

You can adjust network settings to connect to an access point and save the network connection data on the system. Up to ten connections can be saved.

- 1** Select  (Network Settings) under  from the home menu, and then press the  button.
- 2** Select "Infrastructure Mode", and then press the  button.
- 3** Select "New Connection", and then press the  button.
- 4** Enter a name for the network connection.
When you press the  button, an on-screen keyboard ( page 107) is displayed, allowing you to enter characters for the name. You can choose any name you like for the network connection.



When you have finished entering your settings, press the right button to go to the next screen.

- 5** Enter setting information for the access point.

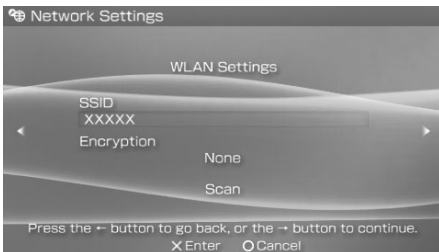

This screen is used to enter information for the settings listed on the next page. Refer to the instructions supplied with the access point or router for setting details.

SSID	Enter the SSID settings for your access point.
Encryption	If a WEP key is set up for your access point, use the directional buttons and select "WEP". Then enter the WEP key. When you enter the WEP key, it appears on the screen as "*****".
Scan	Searches for and then displays a list of access points (or wireless networks) with their corresponding SSIDs and the WEP key status.

When the settings have been completed, press the right button to go to the next screen.

6 Select the address setting method.

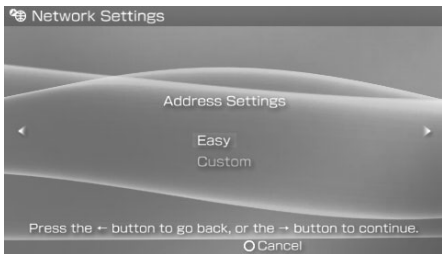

This screen is used to select the settings listed below. Most home networks will allow you to use the settings shown in the "Easy" setup (this is the recommended setup).

Easy	The following information is automatically set. - IP address settings: Automatic - DNS settings: Automatic - Proxy server: Do Not Use
Custom	You can manually enter detailed setting information, such as is used with a static IP network. For details, refer to the instructions supplied with the network device or the information provided by your Internet service provider.

When you have finished selecting your settings, press the right button to go to the next screen.

7 Check the settings.

This screen displays the setting details. Press the left button to return to the previous screens to correct any of the settings, if necessary.

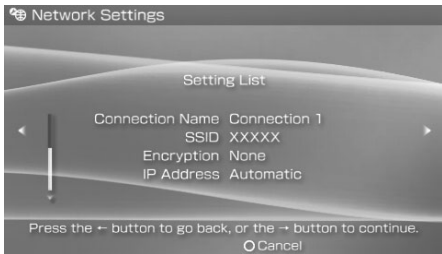

When you have finished selecting your settings, press the right button to go to the next screen.

8 Save the connection.

Press the (X) button to save the connection on your system.

9 Test the connection.

Before testing the connection, check that the PSP™ system's WLAN switch is turned on.

Select "Test Connection", and then press the (X) button. The system will connect to the selected access point.

10 Confirm the connection test results.





If the connection is successful, information about the network connection is displayed. Press the (O) button to end the connection test.

Hints

- The system will also perform an Internet connection test after connecting to an access point. The results of the Internet connection test will be shown in the connection results screen.
- If the connection test fails, follow the on-screen instructions to check the settings. Network settings for the connection can be changed from the options menu (•► page 103). For additional information, refer to the instructions supplied with the network device and by your Internet service provider.
- If the IP address and DNS information will be obtained by a DHCP server, select "Automatic" for both settings.
- Depending on the access point settings, you may need to enter the system's MAC address to connect to the network. The system's MAC address can be checked under "System Information" (•► page 88).

Network settings options menu

When the options menu is displayed in infrastructure mode, network connections saved on the system can be edited or deleted.

- 1** Select  (Network Settings) under  from the home menu, and then press the  button.
- 2** Select "Infrastructure Mode", and then press the  button.
- 3** Select a connection, and then press the  button.

The items listed below are displayed. Select the operation that you want to perform, and then press the  button.

Edit	Changes the settings of a network connection saved on the system*
Test Connection	Tests the connection to an access point
Delete	Deletes a network connection
Information	Displays information about a network connection

* For detailed instructions, see "Creating a new network connection" (**► page 99).

Network Update

You can update the system software using the Network Update feature.

Network update process

Connection to the network

Connects using a wireless LAN access point.
Turn on the system's WLAN switch.



Download (receive data)

Downloads update data from the network. The update data is saved on the Memory Stick Duo™ inserted in the PSP™ system.



Update (software update)

Updates the system software using the data saved on a Memory Stick Duo™.

Notice

During an update :

- do not remove the Memory Stick Duo™
- do not turn off the system
- do not put the system into sleep mode

The system software may be damaged if the update is interrupted.

Starting a network update

You can connect to a network using an access point to download update data.

1 Connect the AC adaptor to the system.

The update cannot be completed if the AC adaptor is not connected.

2 Select (Network Update) under from the home menu, and then press the button.

3 Select a connection, and then press the button.



The system will connect to the network via an access point.

If you have not created and saved a connection, select "New Connection", and then press the  button to display the settings screen. (▶▶ page 99).

4 Download the update data.

When connected to the network, the system automatically scans for the latest update data. Follow the on-screen instructions to download the update data and to start the update.

Hint

Update data saved on a Memory Stick Duo™ can be accessed under  (Game). The update starts when you select the update data and press the  button.

Network update options menu

When the options menu is displayed, connections saved on the system can be edited or deleted.

1 Select (Network Update) under from the home menu, and then press the button.

2 Select the connection, and then press the button.

The following items appear. Select the operation you wish to perform, and then press the  button.

Connect	Connects to an access point
Edit	Changes the settings of a network connection saved on the system*

Delete	Deletes a network connection
Information	Displays information about a network connection

* For detailed instructions, see "Creating a new network connection" (▶▶ page 99).

How to use the keyboard



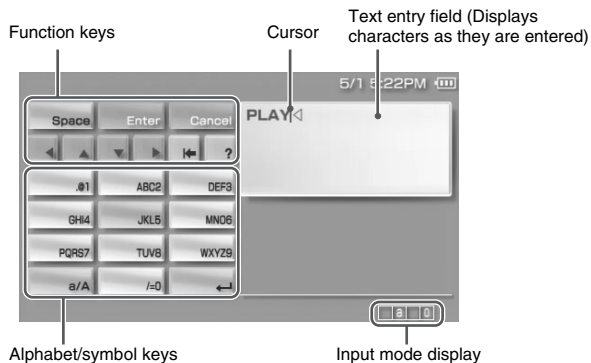





You can use the on-screen keyboard for text entry such as when entering a nickname for the PSP™ system or entering network setting information.



US

Settings



Control panel item list

Keyboard keys	Function
	Enters a space
	Confirms characters that have been typed but not entered, and exits the keyboard
	Cancels characters that have been typed but not entered, and exits the keyboard
	Moves the cursor
	Deletes the character to the left of the cursor
	Displays a diagram showing the system buttons and their usage
	Switches between upper and lower case
	Enters a line break*

* This key is displayed only when two or more lines can be entered.

Switching input mode

The number of input modes available varies depending on the language selected. Every time you press the select button, the input mode switches among the options in the diagram below:







Input mode	Input mode display	Examples of characters you can enter
Letters and numbers		a b c d e
Numbers only		1 2 3 4 5

Hint

The language for the on-screen keyboard is linked to the System Language selected in System Settings. For example, if System Language is set to "French", the French keyboard is displayed. The type of characters you can enter varies depending on the language selected.

Entering characters

This section will demonstrate how to enter text using the word "PLAY" as an example.

- 1 Select PQRS7, and then press the  button several times until "P" is displayed.**
Each time you press the , the character that is entered in the text entry field is switched.
- 2 Select JKL5, and then press the  button several times until "L" is displayed.**
- 3 Select ABC2, and then press the  button several times until "A" is displayed.**
- 4 Select WXYZ9, and then press the  button several times until "Y" is displayed.**
- 5 Select Enter, and then press the .**
The characters you entered will be confirmed. Select Enter again, and press the  to exit the keyboard.

Hint

If you select the a/A key while entering characters, you can switch between upper and lower case.

Entering symbols

You can enter symbols such as "." and "?" by selecting particular keys while entering characters.

Input mode	Alphabet/symbol key
Letters and numbers	





US

Settings

Additional information

Compatible media

The media types listed below can be used on the PSP™ system. Throughout this manual, the term "Memory Stick Duo™" is used to refer to all types of Memory Stick™ media in the table below.

Type	Logo
UMD™	
Memory Stick Duo™	
MagicGate™ Memory Stick Duo™ *1	
Memory Stick Duo™ (MagicGate™/High-speed data-transfer compatible) *1 *2	
Memory Stick PRO Duo™ *1 *2	

*1 Compatible with MagicGate™

*2 Compatible with high-speed data transfer over a parallel interface. The actual data-transfer speed will vary depending on the Memory Stick Duo™-compatible device.

Hints

- Performance of all Memory Stick™ media is not guaranteed.
- If a Memory Stick Duo™ is formatted in a device other than the PSP™ system, such as a PC, it is possible that the system will not recognize it. If this happens, re-format the Memory Stick Duo™ using the PSP™ system.

UMD™

UMD™ contain a region code that is assigned to each sales region. This system can play UMD™ marked with either region code "ALL" or "1".



Memory Stick™

There are two sizes of Memory Stick™: the standard size and the smaller size. The PSP™ system is compatible with Memory Stick Duo™, the smaller sized type. The standard-size Memory Stick™ cannot be used with the system.

Memory Stick Duo Adaptor



The Memory Stick Duo Adaptor (MSAC-M2: a Sony product sold separately) allows a Memory Stick Duo™ to be used with devices that take a standard-size Memory Stick™.

MagicGate™-compatible Memory Stick Duo™



The MagicGate™-compatible Memory Stick Duo™ has been designed with an indented area (see figure **A**) to allow it to be differentiated by touch from the standard Memory Stick Duo™.

MagicGate

MAGICGATE is a term of copyright-protection technology developed by Sony Corporation.

MAGICGATE does not guarantee compatibility with other products bearing the "MagicGate" trademark.

Parallel data transfer (high-speed data transfer)

Parallel data transfer is a high-speed data-transfer technology that allows multiple data input/output connectors on the Memory Stick™ to be used at the same time (parallel interface).

US

Additional information

Formats that can be played

The following formats can be played on the PSP™ system:

Content category	Format	Characteristics
Video	MPEG-4 (MP4 video file that conforms with the Memory Stick Video Format)	A video-compression format
Music	ATRAC3plus™ (including ATRAC3™)	An audio-compression technology developed by Sony Corporation
	MP3	An audio-compression format
Photo	JPEG (conforms with DCF2.0/ Exif2.21)	A standard format for compressing still images, such as those used in digital still cameras

Hint

Depending on the data type, some data items cannot be played.

Specifications

Design and specifications are subject to change without notice.

PSP™ system

LCD screen	4.3 inches (16:9) full-transparent type, TFT drive Approximately 16,770,000 colors displayed
Sound	Stereo speakers
Internal disc drive	Read-only UMD™ drive
Interface	DC IN 5V connector Charging terminals Headset connector IR port Hi-speed USB DC OUT connector Memory Stick Duo™ slot Wireless LAN (IEEE 802.11b)
Compatible codecs	Video UMD™: H.264/MPEG-4 AVC Main Profile Level3 Memory Stick™: MPEG-4 SP, AAC Music UMD™: Linear PCM, ATRAC3plus™ Memory Stick™: ATRAC3plus™, MP3 (MPEG1/2 Layer3) Photo JPEG (conforms with DCF2.0/Exif2.21)
Power source	AC adaptor: DC 5.0 V Rechargeable battery pack: Lithium-Ion rechargeable battery pack
Battery duration	See page 39
Maximum power consumption	Approx. 6 W (when charging)
External dimensions	Approx. 170 × 74 × 23 mm / 6 ¾ × 3 × 1 in (width x height x depth) (excludes largest projection)
Weight	Approx. 280 g / 10 oz (including battery pack)
Operating environment temperature	5° C - 35° C / 41° F - 95° F

US

Additional information

UMD™ laser

Wave length	655-665 nm
Power	max 0.28 mW
Type	Semiconductor, continuous

Wireless networking

Standard	IEEE 802.11b
WEP	128-bit/64-bit
Modulation format	DS-SS (IEEE 802.11b compliant)

AC adaptor (PSP-100 U)

Input	AC 100-240 V, 50/60 Hz
Output	DC 5 V, 2 A
External dimensions	Approx. 46 × 22 × 76 mm / 1 ¾ × 1 × 3 in (width × height × depth) (excludes largest projection)
Weight	Approx. 100 g / 3.5 oz

Battery pack (PSP-110 U)

Battery type	Lithium-ion rechargeable battery
Voltage	DC 3.6 V
Capacity	1800 mAh

Contents

See page 19.

■ Memory Stick Duo™

- Compatible with MagicGate™
- It is able to perform parallel data transfer (high-speed data transfer). This type of high-speed data transfer can be used only with compatible devices. Transfer speed will vary depending on the device used.
- The Memory Stick Duo™ includes capacity that can actually be used (user capacity) and space reserved for system files. The user capacity of the supplied product is approximately 30 MB.

Software

Software developed by the NetBSD Foundation, Inc. and its contributors is used for the communication functions of this product. For more information, see <http://www.scei.co.jp/psp-license/pspnet.txt>

This product adopts S3TC texture compression technology under license from S3 Graphics, Co., Ltd.

This product includes RSA BSAFE Cryptographic software from RSA Security Inc. RSA is a registered trademark of RSA Security Inc. BSAFE is a registered trademark of RSA Security Inc. in the United States and/or other countries.

U.S. and foreign patents licensed from Dolby Laboratories.

A portion of the PSP™ system software requires the following copyright notice:

This software is based in part on the work of the Independent JPEG Group.

Trademarks

"PS" is a registered trademark, and "PS2" and "UMD" are trademarks of Sony Computer Entertainment Inc.

"XMB" and "XMB" are trademarks of Sony Corporation and Sony Computer Entertainment Inc.

"SONY" and "SONY" are registered trademarks of Sony Corporation. Also, "Memory Stick Duo", "Memory Stick PRO Duo", "Memory Stick", "Memory Stick", "MagicGate", "ATRAC3plus" and "ATRAC3" are trademarks of the same company.

The ratings icons are trademarks of the Entertainment Software Association.

ATOK is a registered trademark of JUSTSYSTEM CORP in Japan and other countries.



Windows is a registered trademark or a trademark of Microsoft Corporation in the U.S. and other countries.

Mac OS is a registered trademark of Apple Computer in the U.S. and other countries.

All other trademarks are the properties of their respective owners.

About national export control

This product may fall within the scope of national export control legislation. You must comply fully with the requirements of such legislation and of all other applicable laws of any jurisdiction in relation to this product.

Troubleshooting

Go through this section if you experience difficulty in operating the PSP™ system. Should any problem persist, call SCEA Consumer Services at 1-800-345-7669 for assistance.

Power, battery and charging issues

US

Additional information

The power does not turn on.

- ➔ Check that the system is turned on.
- ➔ Check that the battery is charged (•▶ page 38).
- ➔ Check that the battery pack is properly inserted (•▶ page 25).

The battery does not charge, or does not fully recharge.

- ➔ Check that the AC adaptor and the AC power cord are properly inserted in the system and the electrical outlet.
- ➔ Check that the WLAN function is not in use while charging. The battery cannot be recharged when the WLAN function is in use.
- ➔ Check that the correct AC adaptor for this product is being used.
- ➔ Check that the AC adaptor connector is clean. If not, wipe it with a dry, soft cloth.
- ➔ If charging the battery in an extremely cold location, it may take longer to fully charge the battery.
- ➔ There may be a problem with the battery pack. Try using a replacement battery pack that is marked for use with the PSP™ system, if available.

The battery charge doesn't last long.

- ➔ When using the system in extremely hot or cold locations, the charge may not last as long. Try to avoid using the system in such environments.
- ➔ There may be a problem with the battery pack. Try using a replacement battery pack that is marked for use with the PSP™ system, if available.

The power indicator on the system front is on, but the LCD screen is not displayed.

- ➔ Check that the LCD screen's backlight is not turned off. If it is, press any of the system buttons to turn on the backlight.

The battery loses its charge even when the system is turned off.

- ➔ Because battery power is used even when the system is turned off, it is recommended that you charge the battery frequently. Also, remove the battery pack from the system when the system is not in use for extended periods of time.

Screen

The screen suddenly turns dark.

- ➔ Check the Backlight Auto-Off setting. If it is set to on, the backlight will turn off after the set period of time. Press any of the system buttons to turn on the screen (➔ page 90).
- ➔ Check the Auto Sleep setting. If it is turned on, the screen will turn dark after the set period of time (➔ page 91).

The screen is dark and hard to see.

- ➔ The screen may appear dark, depending on the angle of viewing. Use the display button on the system front to adjust the brightness (➔ page 37).

The black, red, blue and green spots on the screen do not disappear.

- ➔ LCD screens are made with highly precise technology, but in some cases, black spots may appear, or red, blue or green spots may remain on the screen. This is not a malfunction. For details see "Precautions" (➔ page 11).

The color of the screen does not look right.

- ➔ When the month changes or if you change the month under "Date & Time Settings", the background color will change automatically (➔ page 89).

There is no sound.

- ➔ Check that the volume is not set to zero. Try raising the volume (➔ pages 20, 24).
- ➔ Check that the mute setting is not on. Press the sound button on the system front to clear the mute setting (➔ page 35).
- ➔ If headphones are inserted, the system will not produce any sound through the speakers.
- ➔ See "Sound quality is poor" (below) for details.

The volume does not turn up.

- ➔ Check that the AVLS feature is turned off. When turned on, the AVLS feature limits the maximum volume of the headphones (➔ page 92).

Sound quality is poor.

- ➔ If the system is used in an area where there are vibrations, or if it is near strong magnetic objects such as a television, the sound may be distorted and there may be increased background noise. Try moving the system to a different location.

The system does not recognize the UMD™.

- ➔ Check that the UMD™ is properly inserted (label is facing the system rear, etc.). Try taking out the UMD™ and reinserting it.
- ➔ Check that the UMD™ recorded surface is clean. If not, wipe it gently with a soft cloth (➔ page 15).

The UMD™ doesn't play properly.

- ➔ If moisture condensation occurs, remove the UMD™ from the system and do not use the system for several hours until the condensation evaporates (➔ page 15).

The Memory Stick Duo™ cannot be inserted.

- ➔ Set the Memory Stick Duo™ in the proper direction when inserting (➔ page 33).

The system does not recognize the Memory Stick Duo™.

- ➔ If the Memory Stick Duo™ was formatted by a PC, the system may not recognize it. After copying important data to your PC, re-format the Memory Stick Duo™ using the system. For details, see "Format Memory Stick™" (➔ page 87).
- ➔ Check that the Memory Stick Duo™ is properly inserted. Try taking out the Memory Stick Duo™ and reinserting it.
- ➔ Check that the Memory Stick Duo™ connector is clean. If not, the data may not load properly. Wipe the connector with a cotton swab.
- ➔ Check that the Memory Stick Duo™ is compatible with the system (➔ page 110).

The system can't save or load data.

- ➔ Check that there is sufficient free space on the Memory Stick Duo™ to save data (➔ page 44).
- ➔ There may be a problem with the Memory Stick Duo™. Try using another Memory Stick Duo™, if available.

Video

The UMD™Video does not operate.

- ➔ If the playback conditions have been set by the software developer, the UMD™Video may not play as described in this manual.

Videos do not play.

- ➔ Depending on the bit rate, certain videos may not be playable on the system. Check that the video files were converted at a bit rate of 768 kbps or lower.

The system does not recognize a video data item.

- ➔ Video data items in a file format that is not compatible with the system will not be recognized (➔ page 112).
- ➔ If the file or folder name on the Memory Stick Duo™ is changed, or if the file or folder is moved to another location using a PC, the system may not recognize it.

Music

Music does not play.

- ➔ Tracks with an expiration date or a limited number of playing times may not be playable on the system.
- ➔ When playing ATRAC3plus™ data, software compatible with copyright-protection features must be used to transfer the data onto a Memory Stick Duo™ (➔ page 67).

Tracks from other groups do not play.

- ➔ Check that the Group Mode feature is turned off. When turned on, tracks from only one group can be played.

The system does not recognize music data.

- ➔ Check that the MP3 file is saved in the correct folder on the Memory Stick Duo™ (➔ page 69).
- ➔ Music data saved or recorded under a file format that is not compatible with the system will not be recognized (➔ page 112).

A group on a Memory Stick Duo™ cannot be deleted.

- ➔ If there is non-music data in the group, the group cannot be deleted.

Photo

Images do not display.

- ➔ Depending on the image data size, certain images are not viewable.
- ➔ If images are edited using a PC, they may not be viewable.

The system does not recognize the image data.

- ➔ Check that the data is saved in the correct folder on the Memory Stick Duo™ (•▶ page 81).
- ➔ If the file or folder name on the Memory Stick Duo™ is changed, or if the file or folder is moved to another location using a PC, the system may not recognize it.
- ➔ Images in a file format that is not compatible with the PSP™ system will not be recognized (•▶ page 112).

A folder on a Memory Stick Duo™ cannot be deleted.

- ➔ If there is non-image data in the folder, the folder cannot be deleted.

Wireless LAN

A connection to the network cannot be established.

- ➔ Check that the WLAN switch on the left side of the system (•▶ page 23) is turned on.
- ➔ Set the WLAN Power Save mode to Off (•▶ page 91). This will allow the system to communicate at full power.
- ➔ There may be too much distance between the system and the wireless LAN access point or the system and the other player.
- ➔ Check that the network settings (•▶ page 98) are correct. Refer to the instructions supplied with the network equipment and by your Internet service provider to make the correct network settings.
- ➔ Depending on the wireless LAN access point setting, you may need to enter the system's MAC address (•▶ page 88).
- ➔ When communicating with another system in ad hoc mode, both systems must be set to the same channel (•▶ page 98).

Headphones with remote control

There is no sound or the sound quality from the headphones is poor.

- ➔ Check that the headphones are fully inserted into the system (•▶ page 28).

- ➔ Check that the headset connector and the headphone plug are clean. If not, wipe them with a dry, soft cloth. See also "There is no sound".

The remote control does not work.

- ➔ Check that the headphones are fully inserted in the system (➔ page 28).
- ➔ Check that the remote control is not in hold mode. If it is, clear hold mode (➔ page 24).

Other issues

The system or AC adaptor is warm.

- ➔ During use, the system or AC adaptor may become warm. This is not a malfunction.

The system is turned on, but does not operate.

- ➔ Check that the system is not in hold mode. If it is, slide the power/hold switch up to clear hold mode (➔ page 34).
- ➔ Try sliding the power/hold switch up and holding until the power indicator turns off. The system will be completely turned off. Then turn on the system again.

The system does not function properly.

- ➔ Static electricity and other similar occurrences may affect the system's operation. Remove the battery pack and AC adaptor, wait for about 30 seconds, and then restart the system.

When the buttons are pressed, there are no key tones.

- ➔ Check that the Key Tone feature is turned on (➔ page 92).

The date and time are reset.

- ➔ If the battery is not recharged and runs out, or if the battery pack is replaced, the system date and time settings may be reset. Follow the on-screen instructions to set the time and date.

The PSP™ system is not recognized by the PC when connected using a USB cable.

- ➔ When using a USB hub or other devices, depending on the operating environment of the PC, the Memory Stick Duo™ inserted in the system may not be recognized by the PC. Try connecting the system directly to the PC using a USB cable.

You forgot your password.

- ➔ You must restore the system settings to the settings at the time of purchase. Once the settings are restored, the password will return to "0000" and you can change the password (➔ page 93). Use caution when restoring the default settings, as you will not be able to recover your current settings for photo, video and other "Settings" options. For details see "Restore Default Settings" (➔ page 87) and "Settings for the PSP™ system" (➔ page 82).

LIMITED WARRANTY

Sony Computer Entertainment America (SCEA) warrants to the original purchaser that each of the constituent products of this PSP™ system shall be free from defects in material and workmanship for a period of one (1) year from the date of purchase (the "Warranty Period"). If one or more of the above-identified products is determined to be defective during the Warranty Period, SCEA's liability shall be limited to the repair or replacement of this product with a new or refurbished product at SCEA's option. For the purpose of this Limited Warranty, "refurbished" means a product that has been returned to its original specifications. You must call 1-800-345-7669 to receive instructions, and then must deliver the product, freight prepaid, to the authorized service facility specified to obtain repair/replacement services.

THIS WARRANTY SHALL NOT APPLY IF THIS PRODUCT: (a) IS USED WITH PRODUCTS NOT SOLD OR LICENSED BY SCEA (INCLUDING, BUT NOT LIMITED TO, NON-LICENSED GAME ENHANCEMENT DEVICES, CONTROLLERS, ADAPTORS AND POWER SUPPLY DEVICES) OR OTHERWISE NOT COMPATIBLE WITH THIS PRODUCT; (b) IS USED FOR COMMERCIAL PURPOSES (INCLUDING RENTAL) OR IS MODIFIED OR TAMPERED WITH; (c) IS DAMAGED BY ACTS OF GOD, MISUSE, ABUSE, NEGLIGENCE, ACCIDENT, WEAR AND TEAR, UNREASONABLE USE, OR BY OTHER CAUSES UNRELATED TO DEFECTIVE MATERIALS OR WORKMANSHIP; (d) HAS HAD THE SERIAL NUMBER ALTERED, DEFACED OR REMOVED; OR (e) HAS HAD THE WARRANTY SEAL ON THE SYSTEM ALTERED, DEFACED OR REMOVED. THIS WARRANTY DOES NOT COVER PRODUCTS SOLD AS IS OR WITH ALL FAULTS, OR CONSUMABLES (SUCH AS BATTERIES). PROOF OF PURCHASE IN THE FORM OF A BILL OF SALE OR RECEIPTED INVOICE WHICH IS EVIDENCE THAT THE UNIT IS WITHIN THE WARRANTY PERIOD MUST BE PRESENTED TO OBTAIN WARRANTY SERVICE.

REPAIR OR REPLACEMENT AS PROVIDED UNDER THIS WARRANTY IS THE EXCLUSIVE REMEDY OF THE CONSUMER. ANY APPLICABLE IMPLIED WARRANTIES, INCLUDING WARRANTIES OF MERCHANTABILITY AND FITNESS FOR A PARTICULAR PURPOSE,

US

Additional information

ARE LIMITED IN DURATION TO THE DURATION OF THIS WARRANTY. IN NO EVENT SHALL SCEA BE LIABLE FOR CONSEQUENTIAL OR INCIDENTAL DAMAGES FOR BREACH OF ANY EXPRESS OR IMPLIED WARRANTY ON THIS PRODUCT. SOME STATES OR PROVINCES DO NOT ALLOW LIMITATION ON HOW LONG AN IMPLIED WARRANTY LASTS AND SOME STATES DO NOT ALLOW THE EXCLUSION OR LIMITATIONS OF CONSEQUENTIAL OR INCIDENTAL DAMAGES, SO THE ABOVE LIMITATIONS OR EXCLUSION MAY NOT APPLY TO YOU.

This warranty gives you specific legal rights, and you may also have other rights which vary from state to state or province to province. This warranty is valid only in the United States and Canada.

The warranty offered by Sony Computer Entertainment America on your PSP™ system (PSP-1001 K) is the same whether or not you register your product.

SONY



COMPUTER
ENTERTAINMENT ®

www.us.playstation.com